

P&H skag

Maintenance, troubleshooting and repair

Rich Bown

2024-10-08

Table of contents

1	Introduction	4
1.1	This guide	4
1.2	Skeg systems	4
1.3	Versions of the P&H rope skeg system	6
2	System overview	9
2.1	Controller	11
2.2	Connector	12
2.3	Actuator	13
3	Controller	14
3.1	Controller dis-assembly	14
3.2	Inspecting components	16
3.2.1	Slider	16
3.2.2	Rod	17
3.3	Controller assembly	18
3.4	Setting cord length	20
3.5	Ratchet box removal / replacement	21
3.5.1	Removal of older ratchet box	22
3.5.2	Prepare the boat for the new ratchet box	22
3.5.3	Glue in the new ratchet box	23
3.5.4	Reassemble the system	23
4	Connector	24
4.1	Tube	24
4.1.1	Removal/replacement of tube	25
4.1.2	Controller termination	27
4.1.3	Actuator termination	32
4.2	Cord	42
4.2.1	Cord replacement	43
4.2.2	Skeg line attachment to skeg blade	46
5	Actuator	50
5.1	Removal and re-fitting of the blade assembly	51
5.2	Replacing the elastic	53
5.3	Adjusting the elastics	55

5.4	Adjusting the axle width	55
5.4.1	Blade length	56
5.4.2	Blade spokes catching on axle part	57
5.5	Skudder-type actuator	57
5.5.1	Blade assembly removal	60
6	Diagnosing problems	62

1 Introduction

1.1 This guide

This guide describes how to disassemble / assemble, adjust, remove and replace every component of the P&H rope skeg system.

I've owned a P&H boat for many years, and most of the folk I paddle with regularly also paddle P&H kayaks. I tend to end up fixing their skegs when something goes wrong. I also do a fair bit of work keeping the heavily used P&H boats at my canoe club in working order. This guide started as a set of notes for me to remember how to sort out various recurring problems. It's by no means complete and it's been created without any input from P&H / Pyranha Mouldings Ltd. However, I hope you find it useful and that you can avoid some of the frustrations I experienced along the way.

If you do find this useful, perhaps you might consider buying me a (virtual) beer by clicking the link below:



Many thanks to everyone who's allowed me to fiddle with their skegs over the years, as well as those who have been kind and patient enough to help work out how to fix things. Thanks also to Kathleen and Beth for their proof reading and suggestions to improve the clarity of these notes

1.2 Skeg systems

Unlike most types of kayak, the typical British sea kayak has moving parts. The need to keep the boat controllable in wind from different directions necessitates either a skeg or a rudder, and UK based designers have typically opted for skegs. The skeg must be capable of adjustment from fully up (paddling into wind) to fully down (downwind) through a range of intermediate positions (paddling across the wind). Any system with moving parts on a seagoing kayak is subject to salt water, sand and grit and occasional impacts. It must allow

precise adjustment whilst being reliable and field maintainable. As yet, no skeg system seems to perfectly meet these criteria.

The traditional approach to skeg actuation is to run a cable from the slider through a tube to the skeg box. The skeg is lowered by pushing the cable through the tube and raised by pulling the cable under tension. The system is simple and can work well. It is used in (e.g.) Valley sea kayaks. However, if the skeg is inadvertently pushed in (e.g. by hitting a rock or beach), the unsupported length of wire tends to kink, making the system more difficult or impossible to use. Rockpool use a similar system with the wire lowering the skeg in tension to avoid this problem.

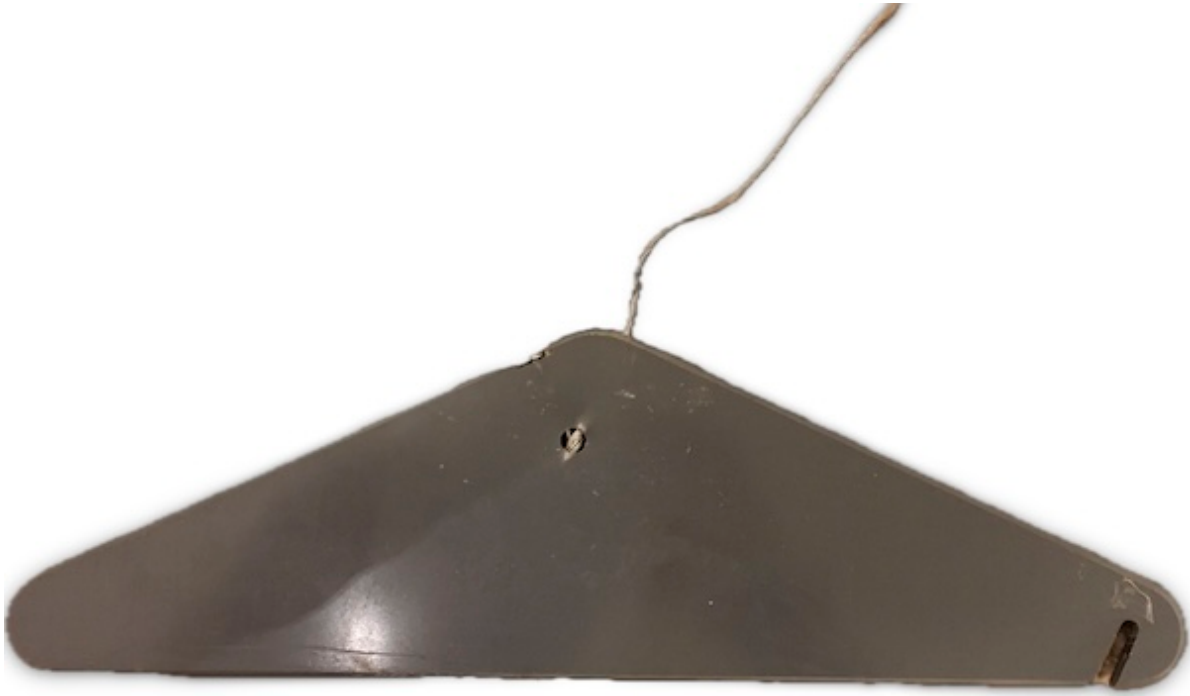

Figure 1.1: Valley wire skeg removed from boat to fix a kinked wire

There have been other approaches to skeg actuation over the years including Kartitek's Hydroskeg, which uses hydraulics to raise and lower the skeg. Being virtually friction-less, the system is a joy to use, but is complex and field repairs are not simple.

An alternative approach is the rope skeg. In this system, the skeg blade is lowered by bungee cords in the skeg box and raised by pulling against these cords using a rope. The rope is held by a jam cleat behind the cockpit. The system is simple and field maintainable, and doesn't require the user to carry a bulky spare cable. However, the rope typically runs across the back deck, making it possible to tangle with kit and during rescues. Fine adjustment of the

system is difficult without any visual index, especially as the jam cleat is usually behind the cockpit.

Around 2007, P&H began fitting their kayaks with a new rope skeg system. The system operated like a standard rope skeg with the use of a bungee to lower the skeg and a cord to raise it. However, rather than a jam cleat, the system used a novel skeg slider with a releasable ratchet system in an attempt to combine the simplicity and maintainability of a rope skeg with the precise adjustability of a wire skeg. The Mark 2 version of the system works well, but maintaining the system can be a little fiddly. These notes are an attempt to help people look after and repair these P&H rope skegs.

1.3 Versions of the P&H rope skeg system

The original P&H system (Mk1), from 2007, used a metal bar to support the button in the skeg slider. The slider ran along a narrow V-shaped channel. In some cases, this system had very high friction. One problem apparently related to the metal bars, some of which were not straight (it is said that they were cut from reels, with the metal from near the centre of the reels being more bent than that from the outside). In 2010, P&H issued a statement acknowledging the problems, claiming that they had been fixed in new boats and offering to fix existing boats under warranty.

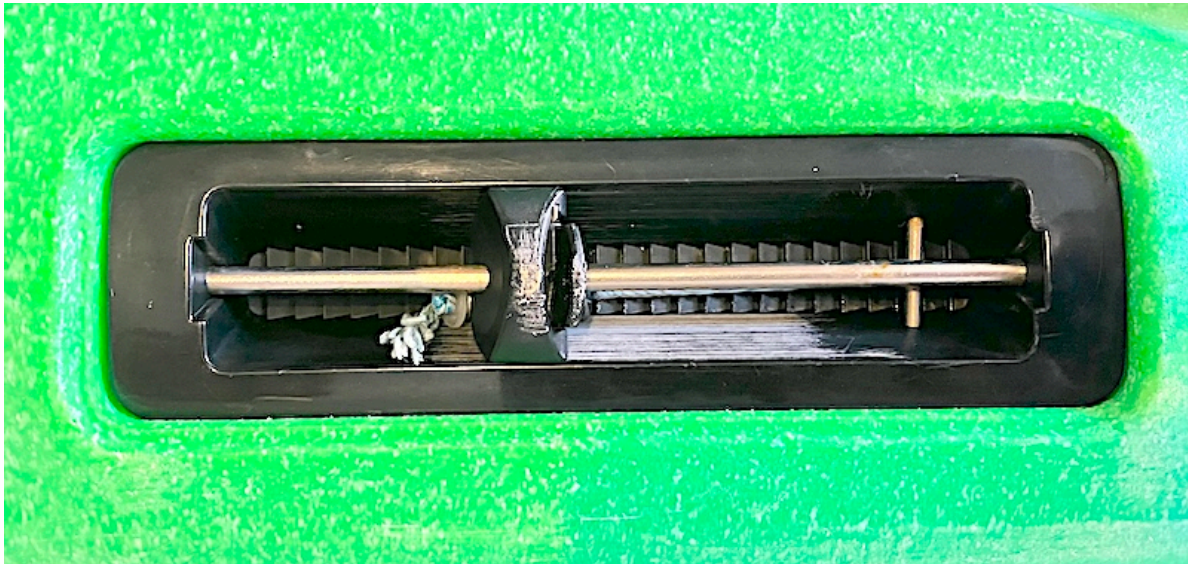

Figure 1.2: The Mk1 controller

In 2011, P&H came up with a revised design for the skeg slider (Mk2). The metal bar was replaced with a composite rod, the housing was changed and the slider button redesigned.

This was a great improvement on the Mk1 system. The new slider box could be retrofitted to old plastic boats fairly easily.



Figure 1.3: The Mk2 controller

In 2015, P&H brought the 'Skudder' system to market. The Skudder can be raised and lowered like a conventional skeg but once lowered, it rotates as a rudder actuated by foot pedals. The Skudder is optional, but boats without it now have a different skeg setup that fits into the same space as the Skudder system. Whilst the skeg slider is unchanged since the Mk2, this 'Mk3' version has a different attachment of the rope to the skeg and the skeg is now internally sprung rather than being pulled down by a bungee cord. The skeg slider occupies a different position in front of the cockpit on boats fitter with this system. We refer to this as a 'skudder-type skeg' in these notes.

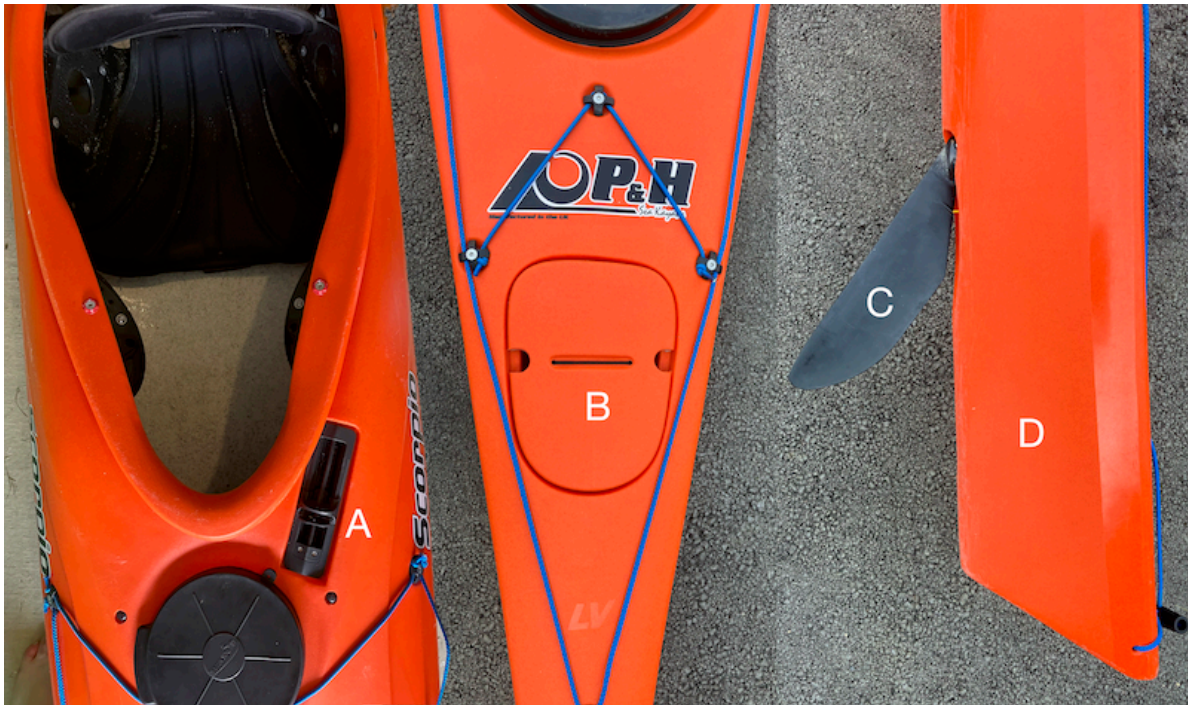
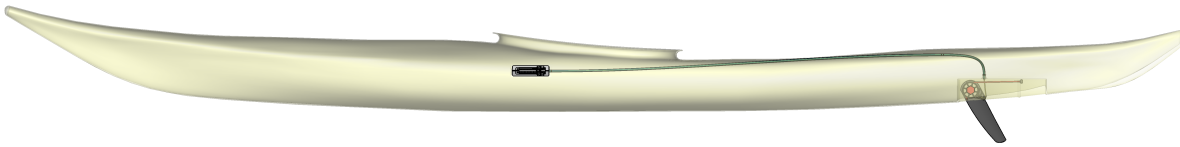

Figure 1.4: Boat with skudder-type skeg, showing new controller position (A), actuator cover (B) and new blade (C) that deploys near the stern of the boat (D).

These notes focus on the Mk2 system, as this is the system I have most experience with. Hopefully it will be useful to those with Mk1 systems (same skeg setup, but different slider, can be upgraded to Mk2) and Skudder-type systems (same slider, different skeg setup).

2 System overview



This section gives a brief overview of the P&H Mk2 skeg system as an introduction to the detailed notes.

The system consists of many components. In this section, we name each component **in bold** and try to use this name consistently throughout. Where possible, one word names are used. In commonly used terminology, the word 'skeg' is often used to describe some of these components (e.g. 'skeg box', 'skeg cord', 'skeg blade'...). In the interests of clarity, we have chosen not to do this - it should be obvious that we are talking about something to do with the skeg, and one word names are preferred (e.g. 'box', 'cord', 'blade').

The skeg system consists of:

- The **actuator** subsystem. Within the skeg box, the blade is pulled down by elastic and raised by the cord.
- The **connector** subsystem. The cord runs within the tube from the skeg box to the ratchet box.
- The **controller** subsystem. The slider box holds the cord at an adjustable position, setting the angle of the blade.

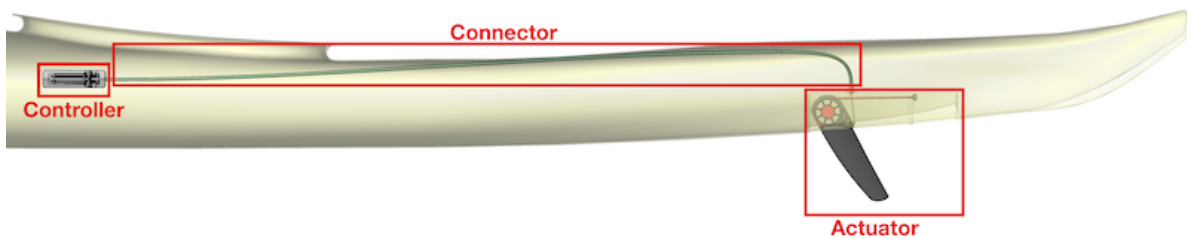

Each of these subsystems is described in overview below. The next 3 sections describe each subsystem and how to maintain it in greater detail.

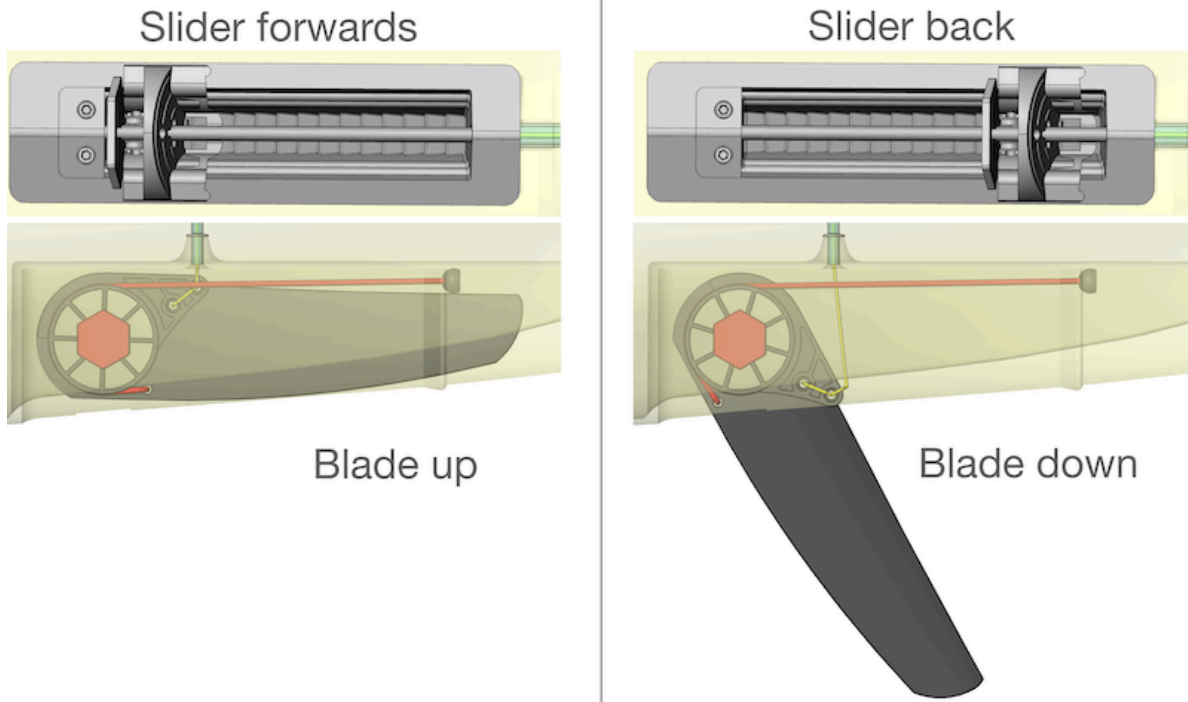

When the slider is set to the forward position, the cord is pulled through the tube and the blade is pulled fully up

When the slider is set to the back position, it releases some cord, allowing the blade to go down under the tension of the elastic.

2.1 Controller

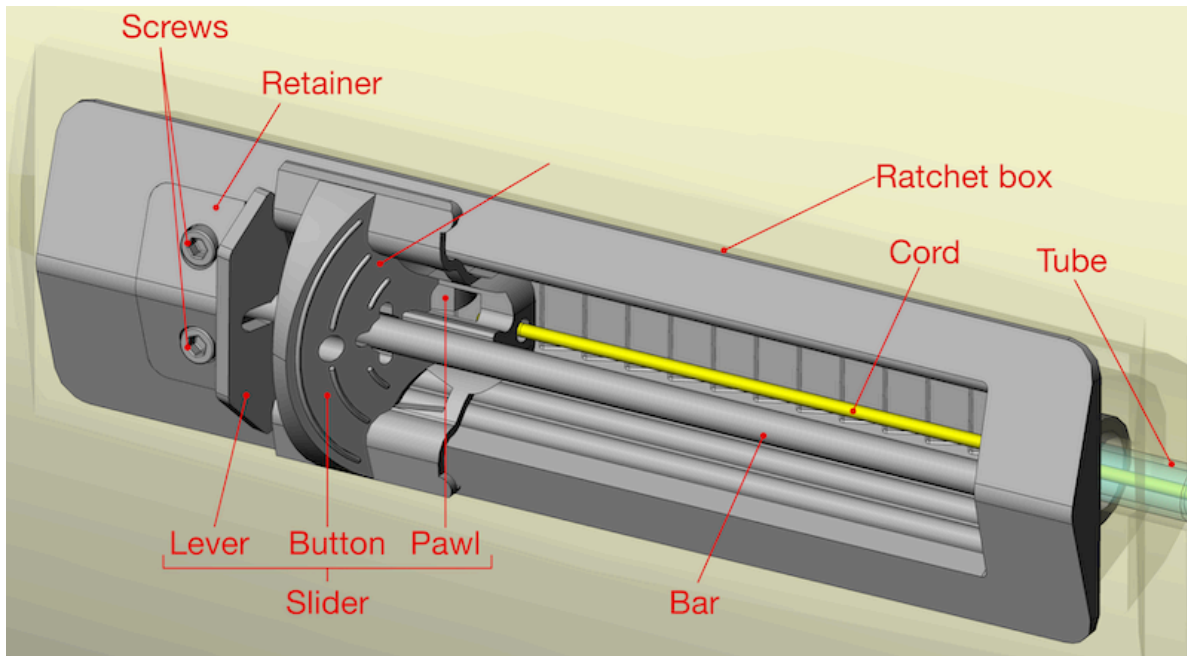

The **ratchet box** is bonded into the **controller recess** in the **boat**. A composite **bar** runs the length of the box, being retained at one end by a hole in the ratchet box and at the other end by the **retainer**. The retainer is held in place with **screws**. The **slider** runs along the bar. It consists of the **button**, the **lever** and the **pawl**. The **cord** is retained in the button with a knot.

The action of the slider box is easier to understand by looking at a section view:

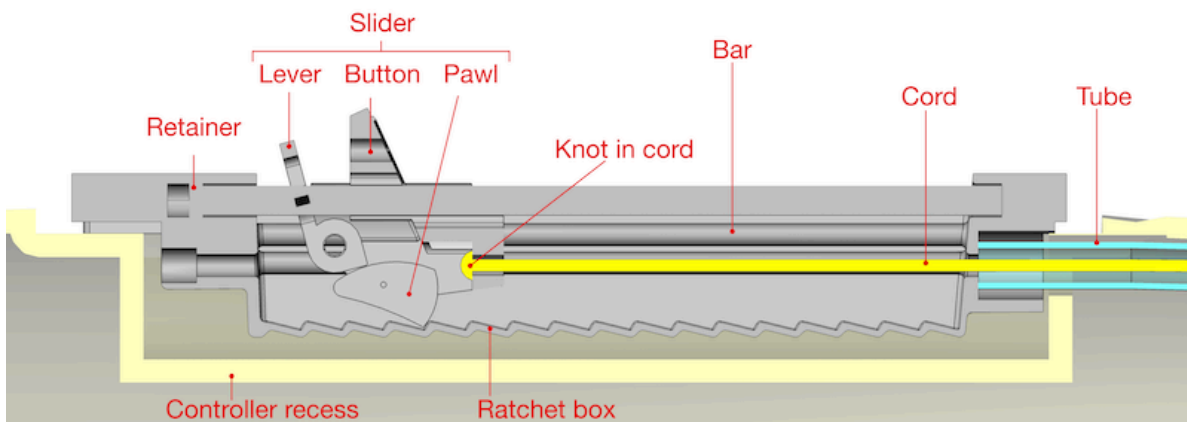

The bottom of the ratchet box has a ratchet surface, with a number of grooves. The pawl engages with one of these grooves under the action of a **spring** (not shown), preventing the

slider moving under the tension in the cord (to the right in the image above). Because of the way that the ratchet surface is shaped, when the slider is pushed to the left, the pawl rides over the grooves, allowing movement. However, no movement is possible to the right unless the pawl is raised by squeezing the lever to the button.

The slider can thus be set at different positions, resisting the tension in the cord. This pays out different amounts of cord down the tube.

2.2 Connector

The connector subsystem consists of:

- A polymer **tube**
- A thin **cord** which runs through the tube
- **End fittings** which connect the tube to holes in the boat at either end

Whilst the connector system seems simple, it can be fiddly to work with. In addition, there are several options for the end fittings at either end of the tube.

2.3 Actuator

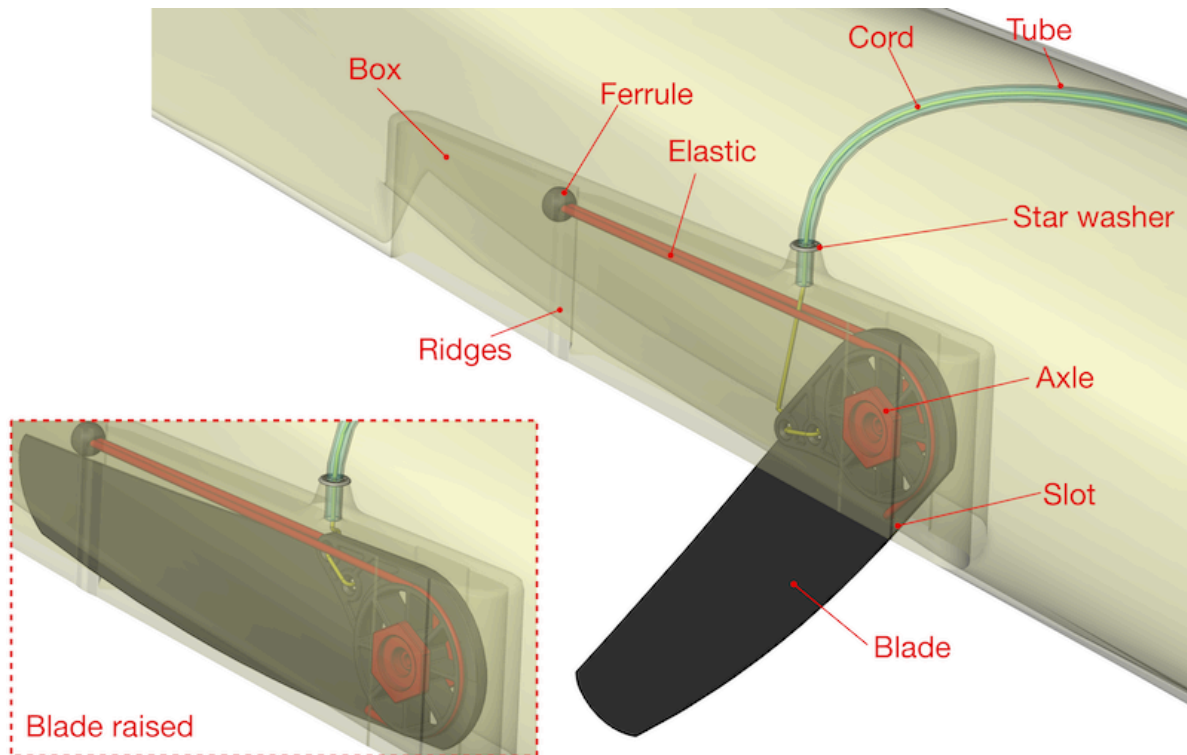

Near the stern of the boat, a recess called the (skeg) **box** is molded into the **boat**. The **blade** rotates on the 2 piece **axle**, which has **male** and **female** parts. The axle is located within a **slot** in the box. A length of **elastic** runs in **grooves** in the blade, tending to rotate the blade to the down position. The ends of the elastic are retained by a knot held in a **ferrule** which is prevented from moving forward by **ridges** in the box. The cord is tied to the blade and pulls it in the opposite direction to the elastic. One option for the tube end fitting, a **star washer** is shown in the diagram.

3 Controller

The controller comes in Mk1 and Mk2 variants. The old Mk1 system ran on a stainless steel bar. It was eventually found that some of this bar drawn from the centre of the reel bowed more than that from the outside of the reel, causing interference and excessive friction in the mechanism. If possible, it is best to replace these with the Mk2. The Mk3 / Skudder system uses the Mk2 controller.

3.1 Controller dis-assembly

The controller may be disassembled using a 2.5 mm Allen key:

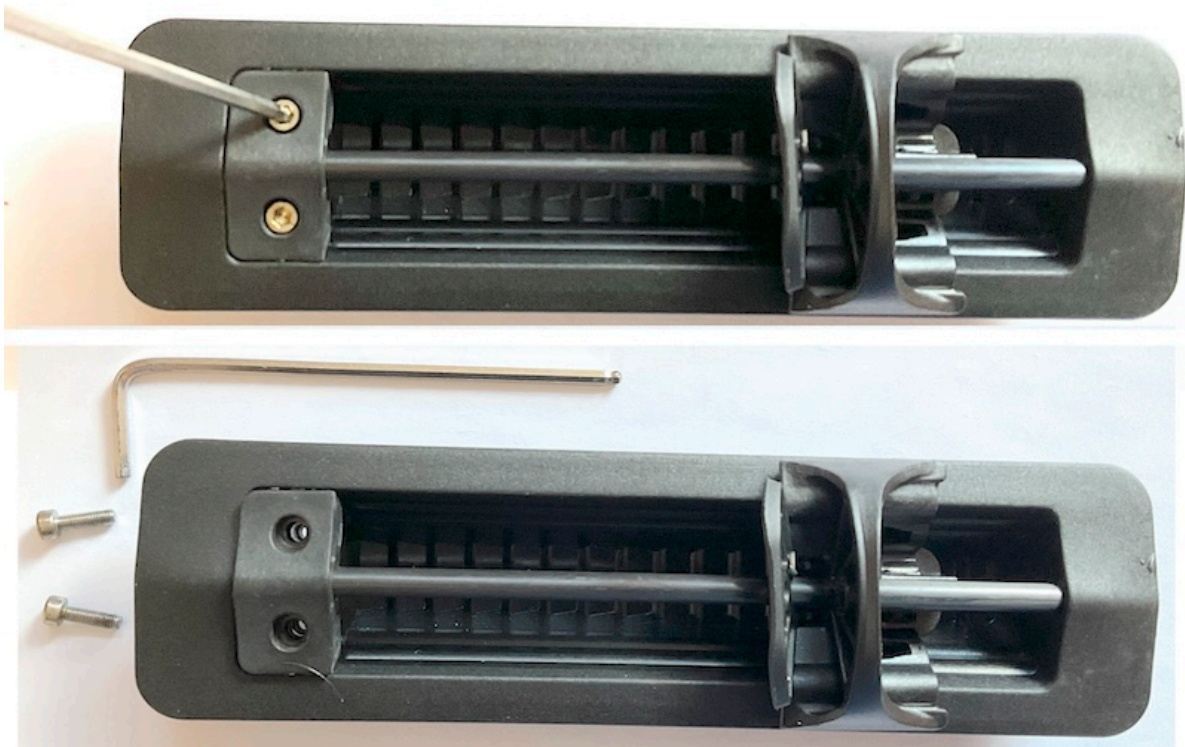

Figure 3.1: 1.Undo both of the screws with the 2.5 mm Allen key and remove them.



Figure 3.2: 2.Slide the bar forwards to release it from the hole at the back of the ratchet box. Remove the bar with the slider on it.

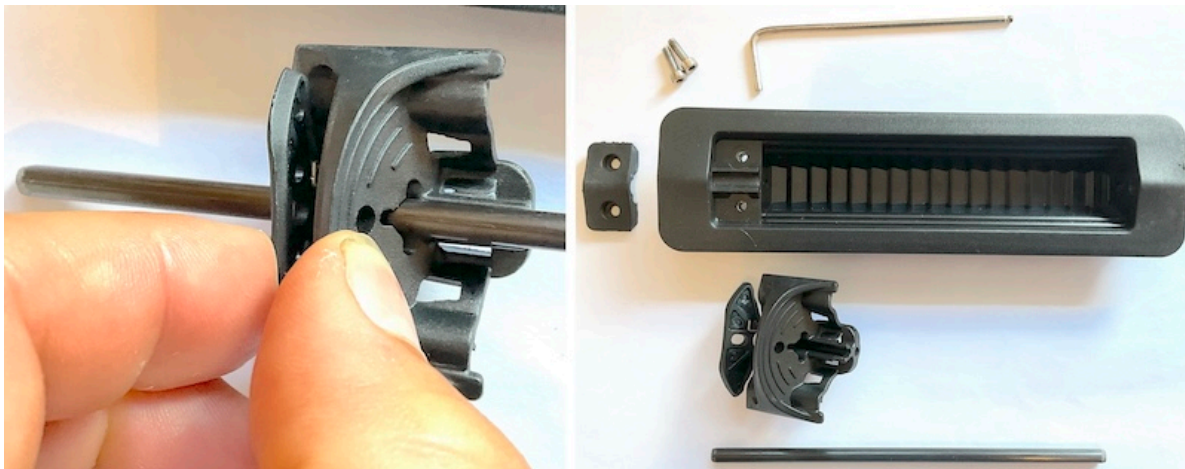

Figure 3.3: 3.Once the bar is removed, squeeze the lever to the button on the slider and slide it off the bar.

3.2 Inspecting components

3.2.1 Slider

3.2.1.1 Broken pawl axle

The button has pivots that appear to use thin plastic axles. These often break, making it hard to actuate the mechanism. If this happens, the pawl on the slider won't sit straight - this is obvious when the slider is removed.

The image below shows a slider removed from the ratchet box with a broken axle on the pawl. The circular part on the pawl component (half of which can be seen poking out) should be concentric with the small notch in the button. This is clearly not the case with this broken component, which had just been removed due to the controller working poorly.



Figure 3.4: Sliders with broken axle on pawl (left) and intact axle on pawl (right)

3.2.1.2 Button cord hole diameter

Some buttons seem to come with very small holes to thread the cord - possibly a relic of the old thin cord. Use small drill bits (e.g. 3.0 mm) to open the hole up until the cord can just pass through (or compare to the button that you have removed).

3.2.1.3 Wear on button rod runner

If the rod has become worn, wear may also occur where the rod contacts the button. If this occurs, the button likely needs replacing.



Figure 3.5: Button worn where it contacts the bar

3.2.2 Rod

The composite rod tends to wear over time. The wear can be seen in the surface finish of the rod and the wear can be felt by rotating the rod between your fingers. It is sometimes possible to see or feel flats worn onto the rod.



Figure 3.6: Two worn rods (top) and two new rods (bottom)

If the rod is worn, it can be replaced. An alternative is to rotate the rod when reassembling the slider box such that the slider is running on less worn surfaces.

3.3 Controller assembly

Assembly is the reverse of the disassembly process. The lever is squeezed to the button and the rod slid into the slider.

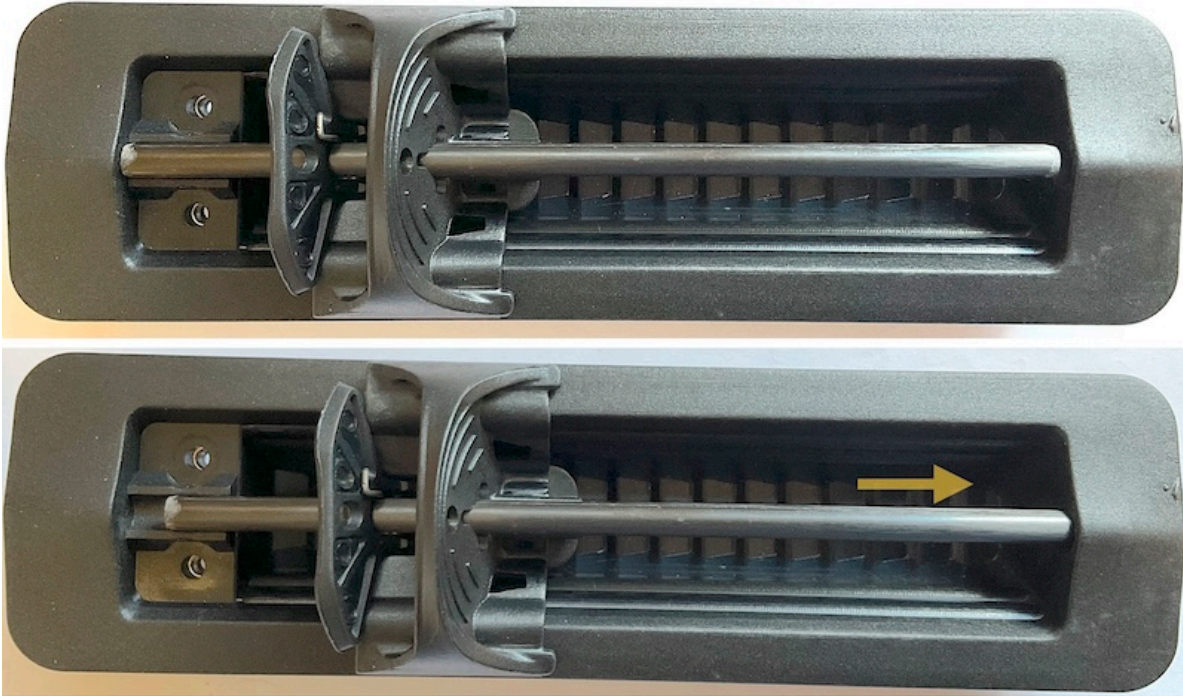

Figure 3.7: The rod and slider are placed in the ratchet box. Check that the slider is assembled in the correct orientation, as shown - the hole for the cord should be towards the stern of the boat and the lever towards the bow. The rod is then slid backward into the hole in the ratchet box.

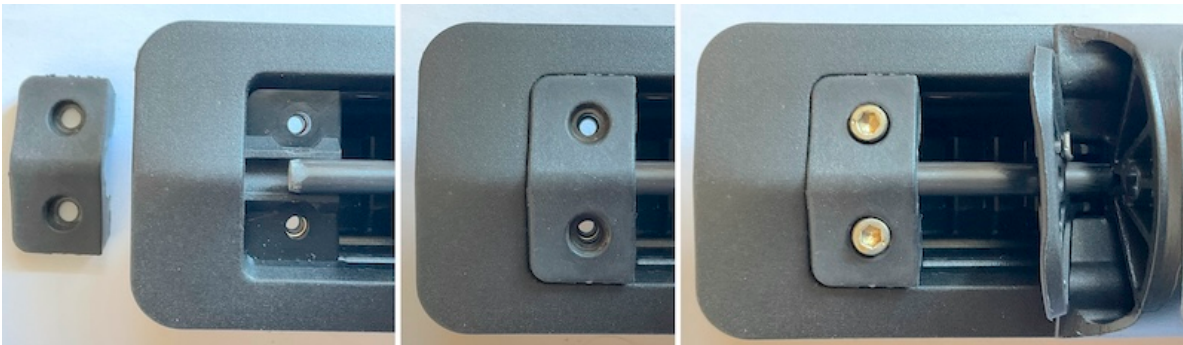

Figure 3.8: Verify that the rod is slid back, such that the retainer drops into place easily. Place the retainer into place, checking that its orientation is correct - the rounded corners go towards the bow to fit with the rounded corners of the ratchet box. Replace the screws.



Figure 3.9: Tighten the screws. Do not over-tighten - max torque = 1.5 Nm (until you feel some resistance and then an another quarter turn, it should be sufficient to only hold the short end of the Allen key)

3.4 Setting cord length

The final adjustment to the system is setting the cord to the correct length and tying off in the button. The aim here is set the system so that:

- When the slider is pulled full forward the blade retracts fully into the boat
- When the slider is fully back, the blade should be at an angle of around 70° to the boat (such that half the lower cord hole in the blade can be seen)



Figure 3.10: Deployed blade (slider fully back) at (approximately) correct adjustment - around 70° to the boat, with the lower cord hole in the blade just visible.

The easiest way to set this is to work with the bar removed from the controller and to slide the slider forwards and backwards as if it were constrained by the bar. Make sure that you have taken any stretch out of the system - e.g. tie the cord off to the decklines in front of the cockpit and gently pull the skag blade down. The process is easier with two people - one at the blade end to take the pressure off as needed, and one at the controller. Pass the cord through the hole in the bottom of the button, just by the pawl. Adjust the length of cord until correct, as described above. Mark the point where the cord meets the hole in the button with a black pen. The instructions say to tie 3 half hitch knots as a stopper at this point, which probably works with the old thin blue cord. With the new yellow cord, a single knot is all that fits into the space. Cinch the knot and check that the system operates correctly. Once you're happy that the knot is at the right place, cut the cord near the knot, then reassemble the controller.

3.5 Ratchet box removal / replacement

The ratchet box component bonded into the boat will rarely need replacing. The most likely reason to want to do this is to replace a Mk1 ratchet box with the Mk2 version. The following instructions are for plastic boats. Due to the adhesives used on composite boats, replacement of the ratchet box is rather more difficult.

3.5.1 Removal of older ratchet box

Disassemble the controller and remove all the components.

The ratchet box is held in place with Soudaflex 40 FC polyurethane sealant. 3M 5200 adhesive can also be used. Applying heat to the ratchet box with a hot air gun weakens the adhesive sufficiently to enable the ratchet box to be removed by prying a screwdriver underneath it, but this will likely cause the ratchet box to be destroyed. Be careful to direct heat into the ratchet box and avoid heating the boat if possible and/or carefully apply force to avoid deforming the plastic around the ratchet box.

Scrape the old adhesive off the boat with a screwdriver



Figure 3.11: Controller recess in boat, with ratchet box removed and most of the adhesive residue scraped away.

3.5.2 Prepare the boat for the new ratchet box

If you are replacing a ratchet box like-for-like, you can now move straight on to gluing the new ratchet box in place. However, if you're upgrading to a Mk2 controller, you've got a bit of work to do first, as the hole for the cord needs to be in a slightly different place.

Although it's not strictly necessary, the first thing to do is to weld the old hole closed. Whilst welding plastic is outside the scope of these notes, this is a fairly simple weld - get both the filler rod and the hole edge hot (they'll go shiny when ready) then push the rod into the hole, twisting it to ensure good contact and to break off the end. I find it easier to place a few layers

of tape across the back of the hole first in order to have a back surface to work against. Be very careful if the boat is a Corelite model, as it's very easy to apply too much heat to the thin outer layer of plastic. Use the smallest flame setting on a small torch.

Find a drill bit of the same diameter as the cord hole in the ratchet box (don't confuse this with the hole for the rod!). Put some ink (e.g. from a permanent marker) on the drill tip and use it to mark the boat through the cord hole.

Drill the hole. P&H recommend a 7mm drill bit to take the compression fitting for the 6 mm tube, but see notes elsewhere in these notes on skeg tube sizes and terminations. Now may well be a good time to replace the tube with the 8 mm tube used on newer boats. Hold the drill as parallel to the boat as you can.

3.5.3 Glue in the new ratchet box

In order to bond in a new ratchet box:

- Sand both surfaces (boat and back of ratchet box)
- Run a flame over the surface of both the boat and the back of the ratchet box
- Apply 3 lines of adhesive to the boat's controller recess (bottom of recess and either side) - Press in the ratchet box, use foam and masking tape to apply pressure whilst the adhesive hardens

Ensure that the ratchet box is assembled into the boat the right way round - the screw holes should be towards the bow of the boat.

3.5.4 Reassemble the system

It should now be possible to reassemble the controller - see notes above.

4 Connector

The tube runs from the slider box to the skeg box, containing the cord.

4.1 Tube

The tube is 8 mm outside diameter, 6 mm inside diameter naturally coloured Nylon 12. It can be purchased in 30 metre lengths (each boat needs around 2 metres!) from RS, stock number 415-0345 (it is used as industrial air hose). Shorter lengths may be available - e.g. on eBay.

Earlier versions of the system used smaller diameter tube with a 6 mm outer diameter, 4 mm inside diameter in Nylon 6.

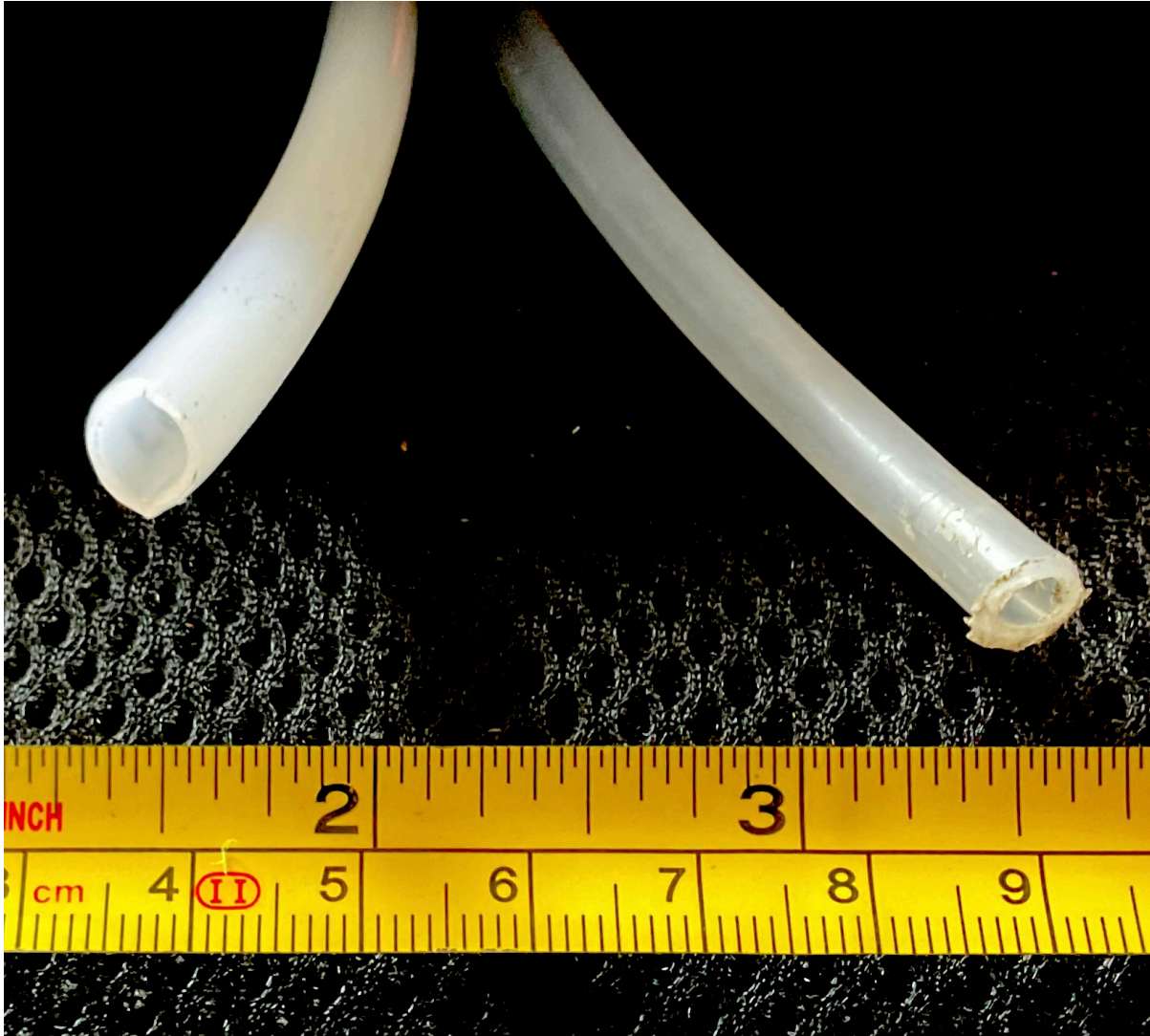

Figure 4.1: Newer (left) and older (right) nylon tubes

The earlier versions seem to have been mostly used with the old, thinner, blue cord, with the larger tube associated with the thicker yellow cord. Replacement of the thicker yellow cord is easier with the new larger diameter tube.

4.1.1 Removal/replacement of tube

It may be easiest to tape the skeg in the retracted position. Begin at the controller - disassemble the controller (see notes on the controller) and either cut or untie the cord from the slider

button. Remove the blade from the boat (see notes on actuator) and pull on the blade to unthread the cord from the tube.

Open both the day hatch and the rear hatch. Pull the tube through the bulkheads between the cockpit, day hatch compartment and rear compartment. In plastic boats, the tube simply runs through holes made in the foam bulkheads. In composite boats, the tube runs through polymeric fittings in the bulkheads.

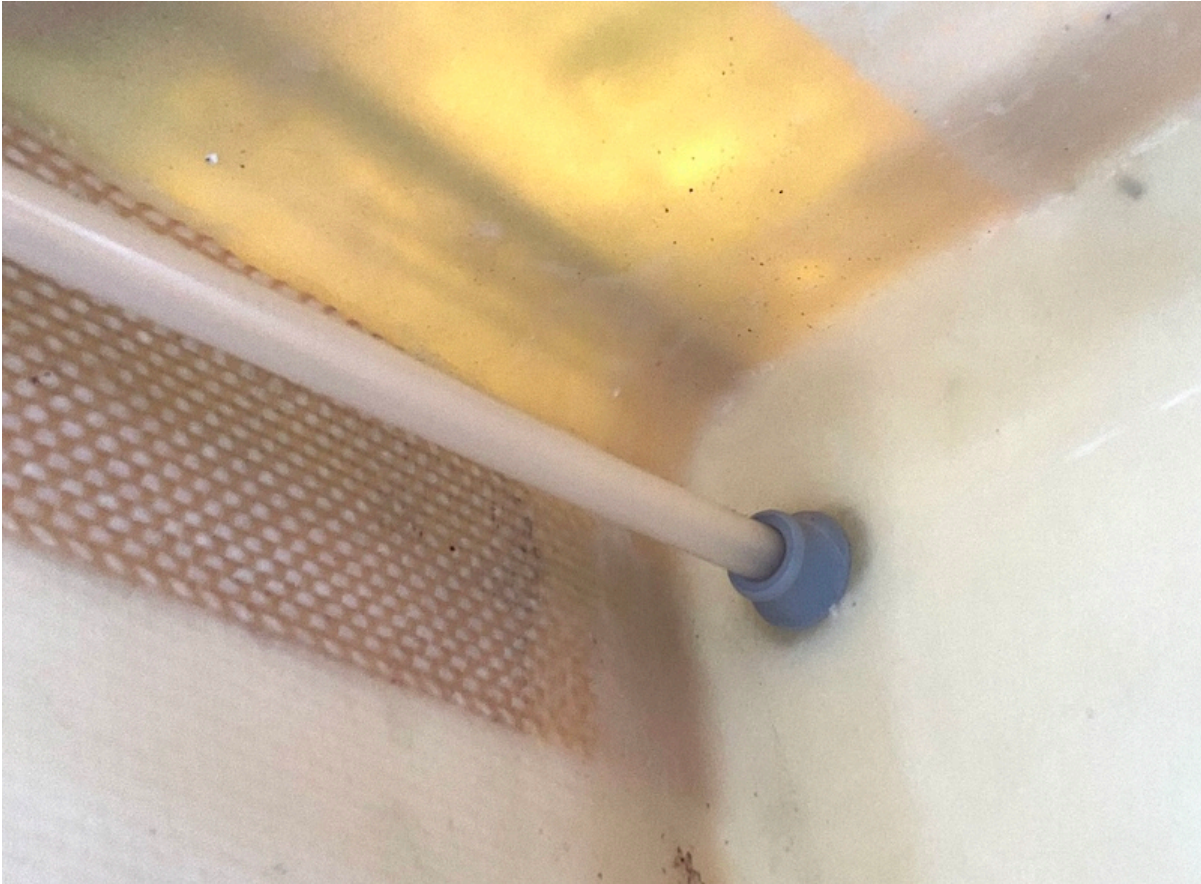

Figure 4.2: Polymeric fitting in composite boat bulkhead with tube passing through.

The tube is held in place in the rear compartment by a P-clip to the deck of the kayak. It may be useful to mark the tube at the P-clip to identify the correct re-attachment point if planning to re-fit or replace the tube.



Figure 4.3: P-clip in fibreglass boat

The bolt holding this P-clip in place also holds one of the recessed deck fittings to the boat in plastic boats. In composite boats, the fitting is glassed in separately. Unscrew the polymer domed nut from the bolt - this should be possible by hand. Fit a socket wrench with a 10mm socket, or adjust an adjustable spanner to an appropriate setting to hold the locknut under the deck. Use an Allen key to unscrew the bolt through the deck fitting (if working on a plastic boat) and remove to free the P-clip. It now remains to remove the tube from the skeg box - see notes below.

Replacement of the tube is the opposite to removal. Care should be taken with the point of attachment for the P-clip to ensure a smooth radius of curvature into the skeg box. However, see notes below on terminating the tube at each end - you may wish to alter the way the tube is terminated, especially if you are replacing an older 6mm tube with a new 8mm tube. It is a good idea to run the cord through the tube before installing the tube into the boat, as this saves the need to thread the cord through the installed tube.

4.1.2 Controller termination

At the controller end, the cord must pass through a hole in the boat aligned with the hole in the ratchet box.

4.1.2.1 Pneumatic line fitting

Some composite boats are fitted with a pneumatic line type fitting in the controller recess. To remove the tube, first push down the top of the fitting before pulling the tube out.



Figure 4.4: Pneumatic line fitting in a composite boat

Some newer plastic boats (I've only seen this with boats with a skudder-type skeg) also use pneumatic fittings at the controller end of the tube.



Figure 4.5: Pneumatic line fitting in plastic boat with skudder-type skeg

4.1.2.2 Polymer compression fitting

In P&H's original design, 6 mm outer diameter tube was used throughout the system. This was found to increase friction and made replacing the cord difficult. 8 mm tube is now used (see above). However, the fitting for the hole in the boat is a 7 mm outer diameter, 6 mm inside diameter plastic sleeve / push fitting. In the newer design, the 8 mm tube is thus attached using heat shrink to a short length of 6 mm tube that interfaces with the push fitting. The push fitting is bonded into the hole in the boat with superglue (cyanoacrylate adhesive).

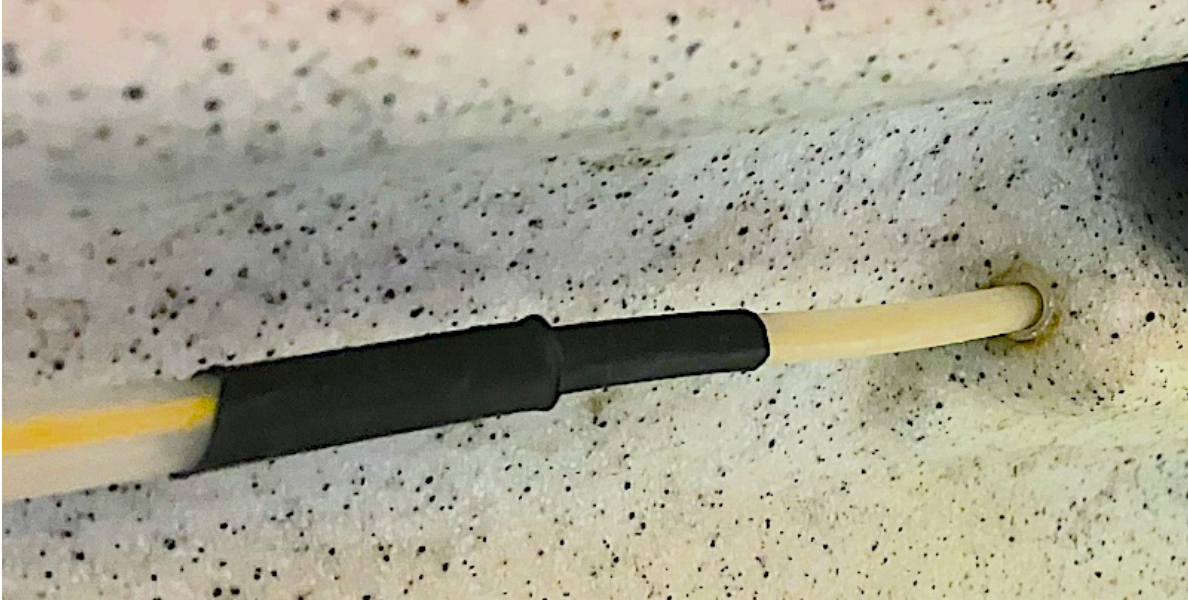

Figure 4.6: Compression fitting termination in boat with 8mm tube. The 8mm tube is connected to a short length of 6mm tube with some black heat shrink. The 6mm tube goes into a push fitting bonded to the hole in the boat at the back of the slider box.

4.1.2.3 Suggested grommet fitting

I prefer a different and simpler approach when replacing the skeg tube in a plastic boat. This avoids the need for the short section of thinner tube, making skeg cord replacement simpler in the future and removing a potential source of friction from the system. The 8mm tube is taken right to the ratchet box and a rubber grommet is used to seal the hole.

Enlarge the 7mm hole in the boat to 11 mm. This can be done with a drill, but it may be sensible to remove the seat from the boat to allow the hole to be drilled straight. I normally find it simpler to twist the drill bits by hand. This works well if the hole is opened up progressively in 0.5 mm steps. A larger drill bit can be used to slightly chamfer the hole to make the next step of grommet insertion easier. Remove any shavings of plastic from the hole.

Once the hole is enlarged and cleaned up, insert a rubber grommet (SES Sterling Black Polychloroprene 11mm Round Cable Grommet for Maximum of 8 mm Cable Dia. - RS stock number 136-6294, SES Sterling part no. 02520323010).



Figure 4.7: Grommet, full length before trimming

Cutting 6 mm off the end of the grommet allows more freedom of movement in the end of the tube to align itself with the slider box. The tube then fits snugly into the grommet.



Figure 4.8: 8mm tube running to slider box with grommet

The insertion depth of the tube using this method is around 17 mm, although it can, of course, be measured by inserting the tube and marking the insertion with a fine permanent marker. This helps with setting the length of the tube. Once the P-clip is secured at the rear of the boat, the tube can be slid through the bulkheads so that it sits fairly straight. The point where it passes through the hole in the boat can then be marked, and the insertion depth (e.g. 17 mm) can then be added to determine where to cut the tube. For rough cuts of the tube, a pair of cable cutters can be used. A hacksaw gives a better finish for final cuts. A large drill bit can be used to slightly chamfer the inside of the tube and a knife or needle file used to chamfer the outside to aid insertion into the grommet.

4.1.3 Actuator termination

Several methods have been used by P&H to terminate the tube at the skeg box depending on boat type (plastic / composite) and age. In addition, other approaches are suggested below

that the author has used.

4.1.3.1 Brass pneumatic fitting

Older plastic boats with 6 mm tube and newer composite boats use brass pneumatic line fittings screwed into the top of the skeg box.

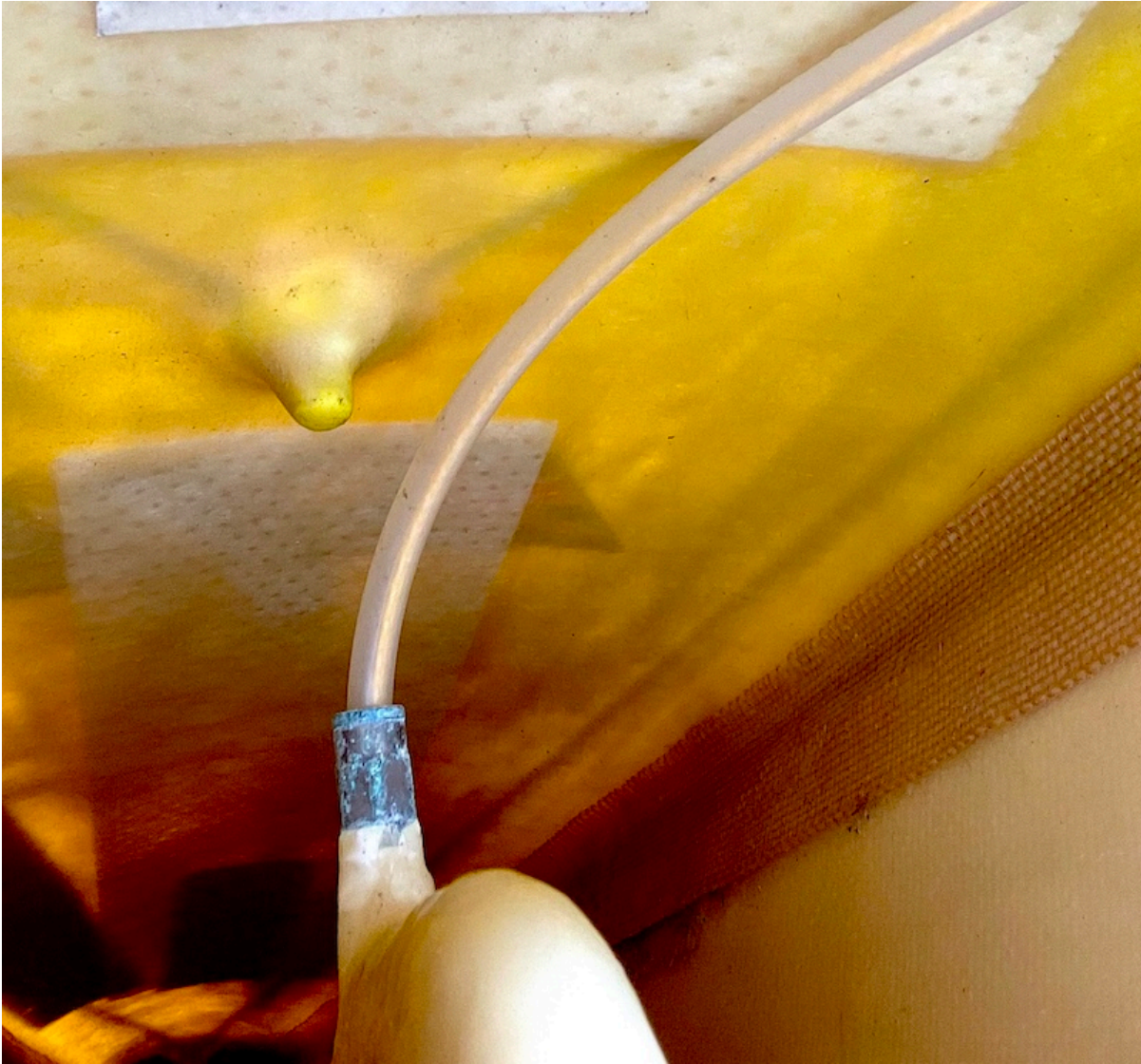

Figure 4.9: Compression fitting in composite boat



Figure 4.10: New pneumatic compression fitting

In theory, these fittings can be released by pushing down the top collar around the tube and pulling the tube out. In practice, they tend to seize up over time, and removing the tube may involve breaking the fitting - see below.

Removing these fittings from the boat can be tricky. The threads have a PTFE coating, and will likely be seized with salt and grit. The upper fitting can be turned with either a 12 mm spanner or a 4mm allen key placed deep into the fitting.

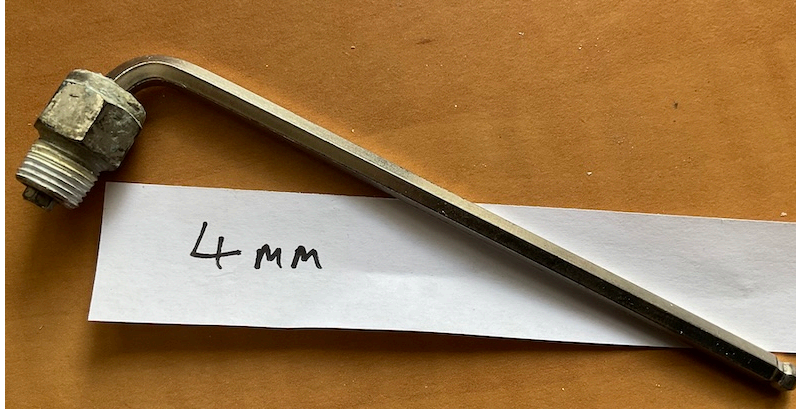

Figure 4.11: 4 mm Allen key keyed into old brass fitting

The Allen key or spanner can be used to rotate the fitting until the flats on the nut visible inside the skeg box are aligned across the boat. This nut can then be gripped with mole grips. Once the mole grips are tightly applied, the grips are held from rotating by the walls of the skeg box, making it easier for one person to remove the fitting.



Figure 4.12: Using mole grips to grasp the nut on the compression fitting

4.1.3.2 Brass fitting and Sugru

Where the plastic parts of the compression fitting have been destroyed, it is possible to place the end of the tube loose into the hole in the top of the fitting and seal the hole up with Sugru.



Figure 4.13: Brass fitting installed in boat with plastic part missing

Sugru, also known as Formerol, is a patented multi-purpose, non-slumping brand of adhesive silicone rubber that resembles modelling clay. It is made by Tesa. It comes in small sachets, which make it easy to carry in a small repair kit. 2 sachets are typically needed to seal the tube joint at the skeg box. Whilst Sugru will not bond properly to the polyethylene material of the kayak, it does provide a decent seal, although it may need replacement if it is disturbed (e.g. by packing the boat with expedition kit).



Figure 4.14: Sugru

4.1.3.3 Retaining washer and sealant

In plastic boats with the 8mm tube, P&H molded a boss on the top of the skeg box, such that it inserts into a longer bore through the plastic.

A retaining washer is placed on the tube to set the insertion depth into the skeg box. The retaining washer is described as an 'Open style push-on retainer, 8mm shaft', RS stock number 172-379.



Figure 4.15: Star washers, RS stock number 172-379

The washer is pushed onto the tube a distance of around 19 mm. It can be pushed into place using an appropriate deep socket - I used a 13 mm socket, although anything in the range 9 - 13 mm would likely work. These star washers can fail over time and need replacing.



Figure 4.16: Star nut pressed on to tube end

Soudaflex 40FC can be used as a sealant/adhesive to seal the tube into the long hole in the plastic. Prior to bonding to the skeg box, it is useful to perform a test assembly without sealant and to mark the point where the tube enters the P-clip with a permanent marker (OHP pens work well). A thin bead of Soudaflex is placed in a ring around the tube below the retaining washer, before inserting into the skeg box. Attaching to the boat with the P-clip holds this joint in place during the ~24 hour drying period.

4.1.3.4 Retaining washer and Sugru

When a 6mm tube is replaced in a plastic boat with an 8mm tube, the boat will not have the longer bore to seal the tube within and the old compression fitting will be too small to accommodate the new larger diameter tube.

Instead, place a retaining washer a short distance from the end of the tube (see above), then seal over the joint with Sugru (see above). It may be sensible to use tape (e.g. Flex Tape) to tape the tube to the deck of the kayak to keep it firmly in place. Flex Tape can also be used to cover the Sugru, providing a backup seal or a field repair.

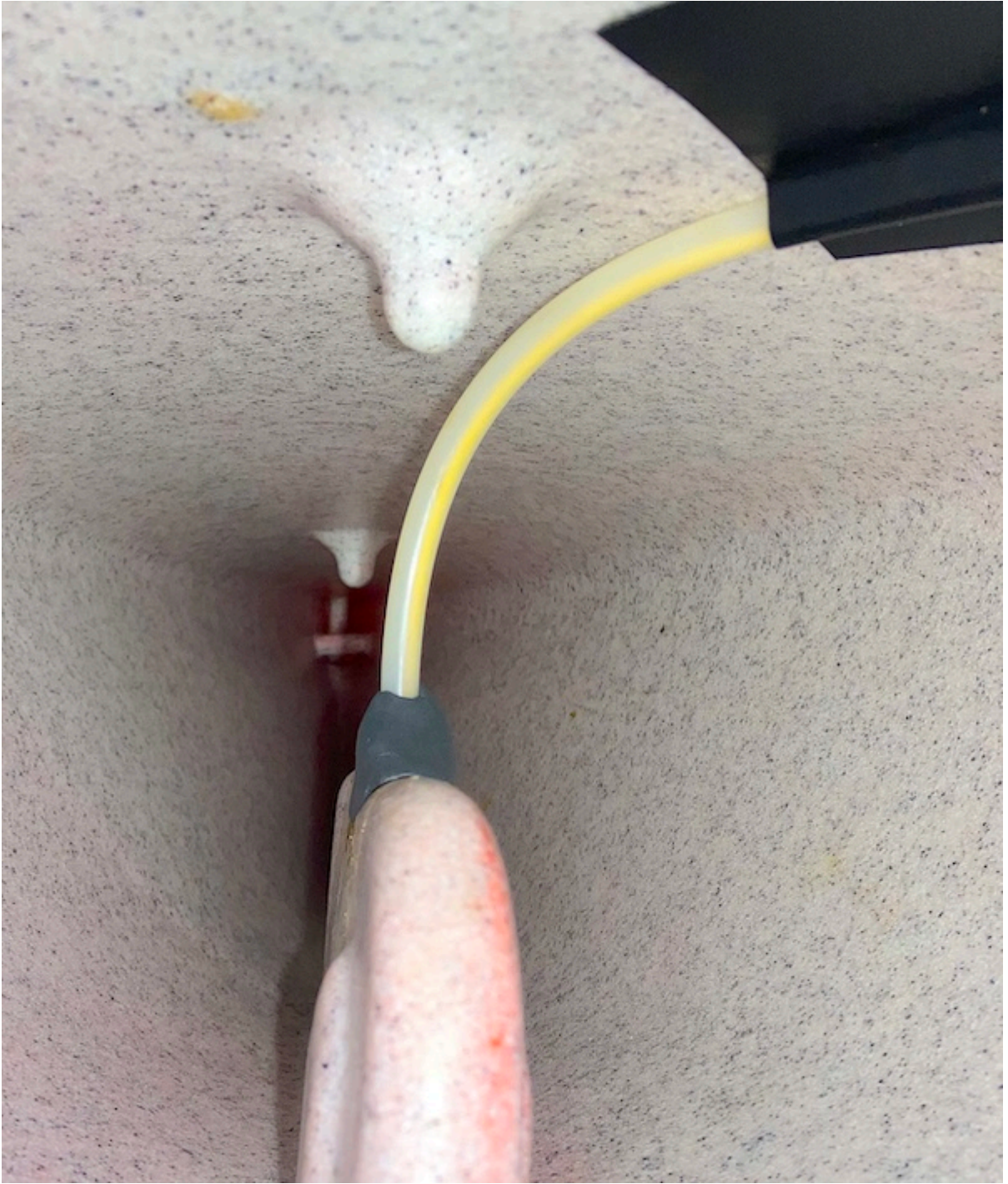

Figure 4.17: Skeg tube held in place with Flex Tape and Sugru

4.2 Cord

P&H have changed the cord from blue 'kite cord' to a thicker yellow cord. P&H replacement skeg line can be purchased from kayak shops.



Figure 4.18: New thicker yellow cord. If possible, buy the cord in longer lengths as it gives more options for threading into the tube.

The new cord is Yellow 2.5 mm diameter 'D Core 78' made by Alpha Ropes. This is a single braid rope with 12 strands of coated Dyneema Sk78 (HMPE with a specific gravity of 0.98 and a 150 C melting point). The cord has a quoted breaking strain of 6 kN (608 kg). At 10% of this load (60kg, which is rather greater than any loads expected in your skeg line, the stretch in the cord is only 0.43%.

The cord does not respond well to attempts to heat seal the ends. Instead, one source suggests that you wrap the end tight with tape, make a neat cut through the tape and cord, then put

a few drops of superglue on the cord. Once the glue has dried this should give an end similar to that usually achieved by heat sealing.

4.2.1 Cord replacement

One of the biggest problems in maintaining the P&H skeg system is passing the cord through the tube. Whilst it is preferable to keep the cord threaded if possible (try tying the line onto a washer to stop it disappearing into the tube), this isn't always possible. And the cord will sometimes need replacing - in fact I tend to like to replace the cord on most systems that I work on - it doesn't cost a lot, there's often limited adjustability without replacing the cord and it'd be a pain to have one fail in use.

Several techniques have been suggested to replace the cord. Begin by disconnecting the cord from the slider, by untying or cutting (after removing the slider from the ratchet box). Remove the blade from the skeg box and untie the cord from the blade.

Several methods for threading the cord through the tube are given below.

Once the skeg line is threaded, tie one end off to the deck lines at each end to prevent either end disappearing back into the tube. Attach the skeg line to the skeg blade - see below - and finally, attach the cord to the slider, setting the cord length correctly.

4.2.1.1 Push the new cord through

I've heard it claimed the P&H have advised people to simply push the cord through the tube. I've not had much success with this!

4.2.1.2 Pull through with old cord

Tie the new cord onto the old with a single fisherman's knot, pulled tight and with the ends trimmed close to the knot. Two options for knot are shown below:

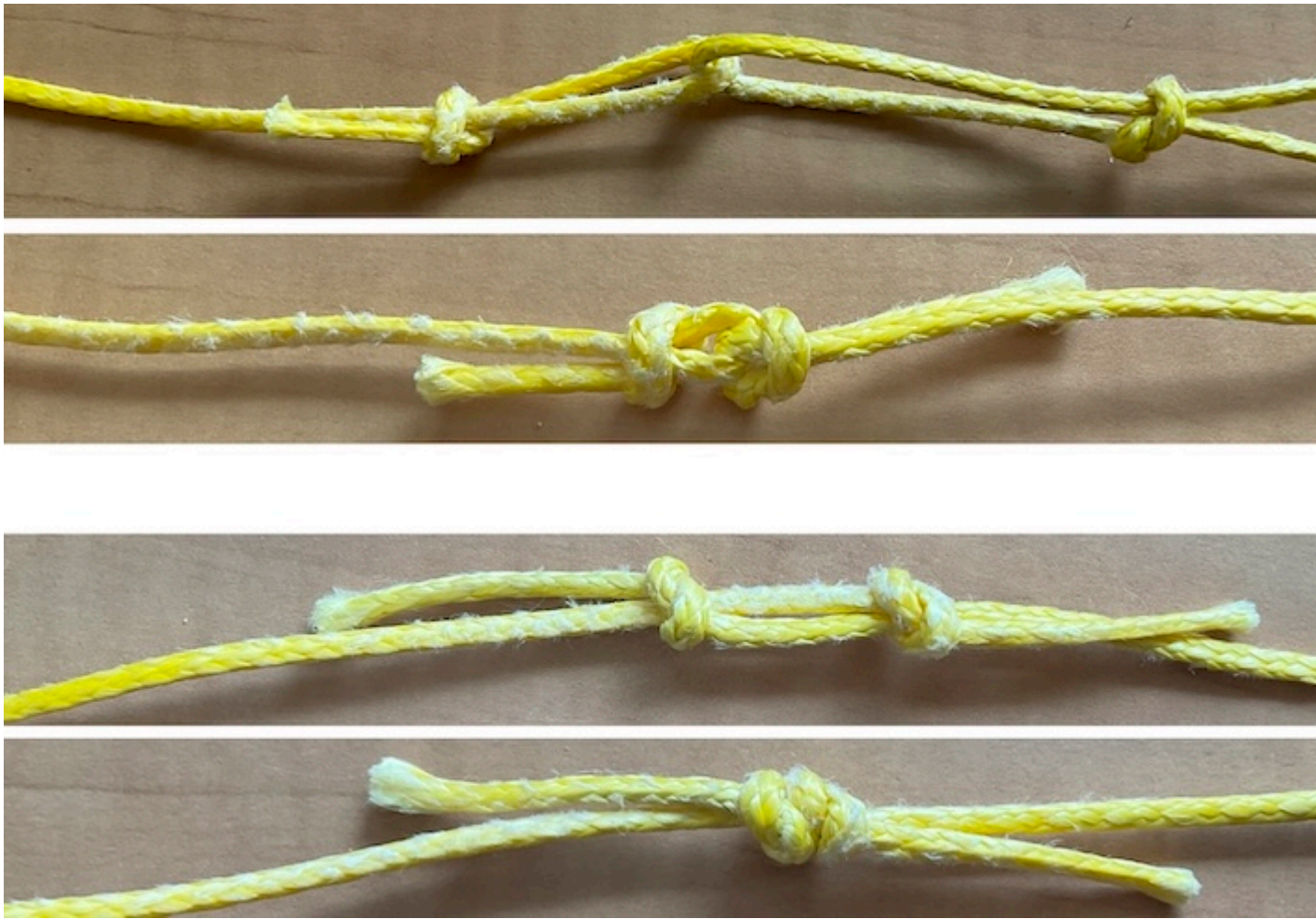

Figure 4.19: 2 possible knots to tie the cords together. The top two images show knots forming interlocked loops. The bottom shows a fisherman's bend.

It can be hard or impossible to pull the knot through the system. This is not surprising - the knot is around 8-9 mm across and it needs to pass down a 6 mm diameter tube.



4.2.1.3 Remove tube partially or completely

Remove the tube from the bulkheads of the boat, and perhaps from the P-clip. Push the cord in from the skeg end of the tube. Whilst one person continues to push the cord in, shake the end of the tube aggressively, or spin it around. The centrifugal force that this generates helps the cord to thread.

If the tube is removed completely from the boat, it is usually possible to simply push the cord through. However, several of the systems for attaching the tube to the skeg box are fairly permanent, so this is not ideal.

4.2.1.4 Using wire or cable

Perhaps the best method is to run a wire or cable through the tube, then use this to pull the cord back through the system.

The ideal wire is stiff enough to be pushed through the tube, but flexible enough to go round the corners easily, and be wound into a tight loop to be stowed in a repair kit. I'm currently using 1.5 mm 7x7 stainless steel wire rope, which seems to work well.



Figure 4.20: 1.5mm 7x7 stainless steel rope

The rope has a sharp bend crimped into it with pliers around 40 cm from the end:



Figure 4.21: 1.5mm 7x7 stainless steel wire rope with sharp bend

This can be passed through the tube (once disconnected from the ratchet box), bend first. Stop once the bend in the wire just emerges from the bottom of the skeg box.

Ideally, a cord of a little over twice the length of the tube is used. The midpoint can be looped around the wire loop before pulling the cord doubled back through the system. If this is impossible, simply looping the end of the cord through the wire and leaving a 20 cm tail seems to work. The friction of tail with the wire and the tube seems to be sufficient to hold it in place as it is pulled through.

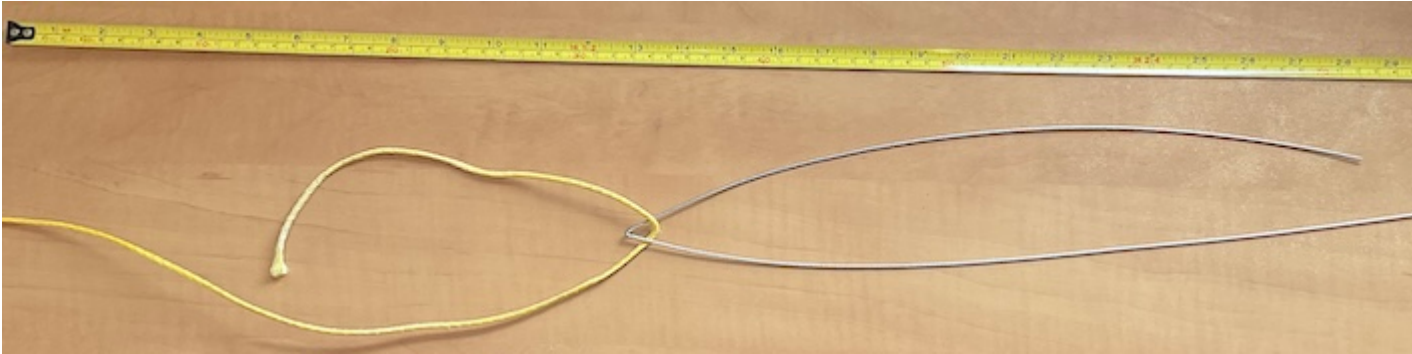

Figure 4.22: Cord looped through wire

4.2.2 Skeg line attachment to skeg blade

Feed the skeg line through the upper hole, through the lower hole then back through the upper hole again.

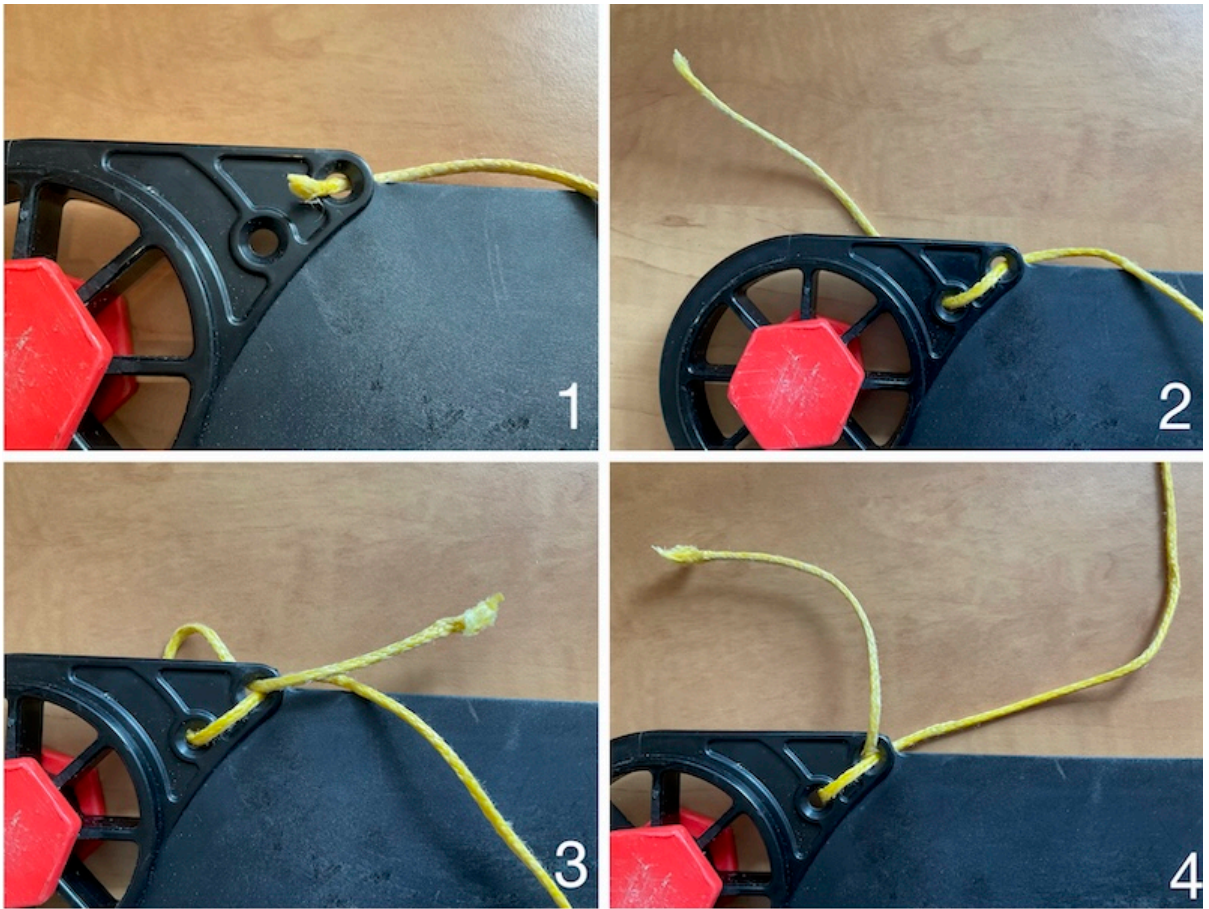

Figure 4.23: Threading the cord onto the blade

Use half hitches to tie onto the incoming cord, either onto the incoming rope or on the side of the blade between the cord holes.

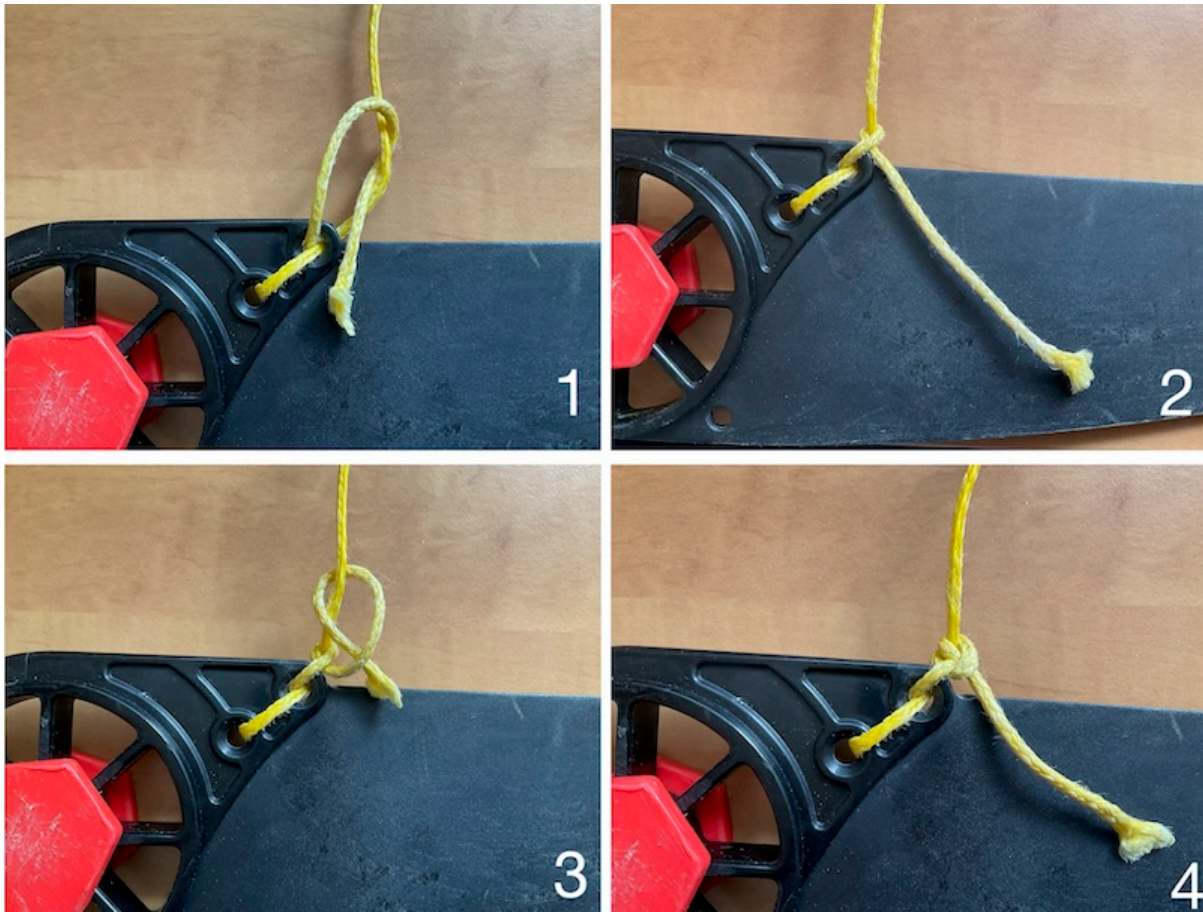

Figure 4.24: One approach to knotting the cord onto the blade with half hitches above the blade. This tends to work well, but the knot might hit the end of the tube preventing the blade fully retracting. In practice, this doesn't seem to be a problem.

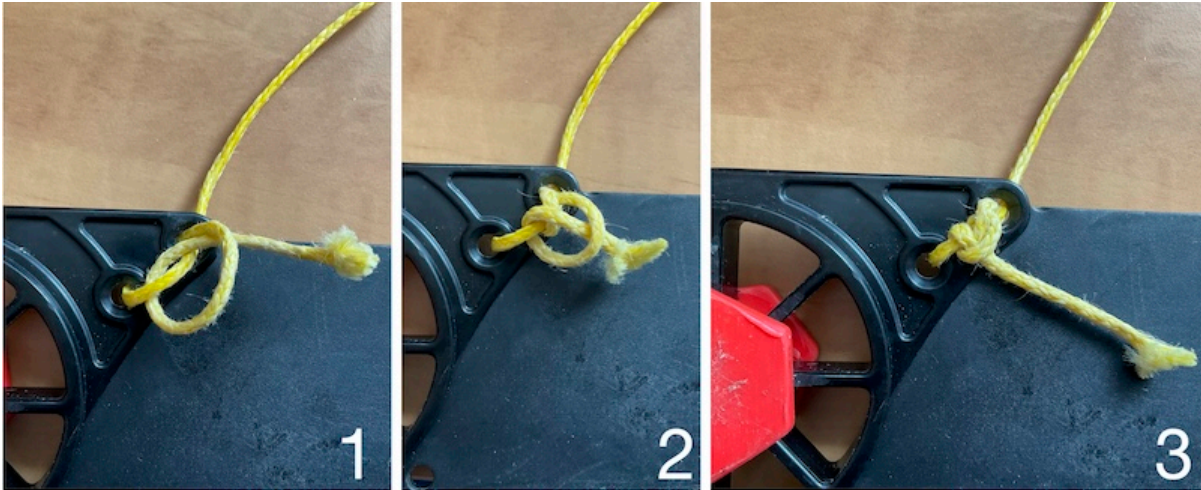

Figure 4.25: Alternative approach to tying off cord on the side of the blade. Whilst there is now no knot above the skeg, the knot does add some bulk to the side of the blade which may catch on the walls of the skeg box.

Finally, trim off excess cord leaving just a short tail (~1-2 cm).

5 Actuator

The blade rotates on a 2 piece axle that jams into a slot in the boat's skeg box. Elastic wraps around circular grooves in the blade and extends backward to a ferrule. The ferrule is restrained by ridges in the skeg box, preventing it from sliding forwards and thus applying tension to the elastic.

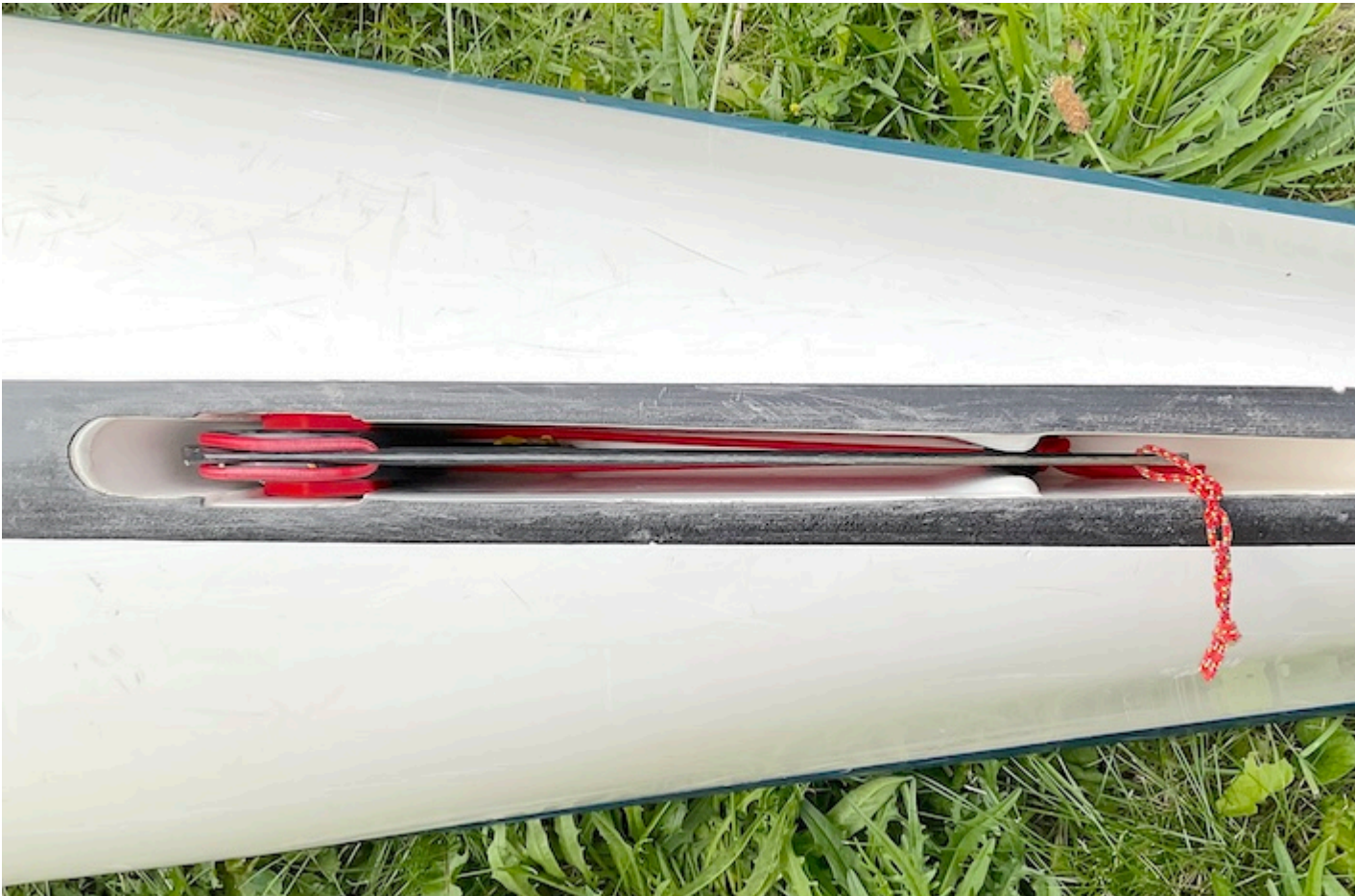
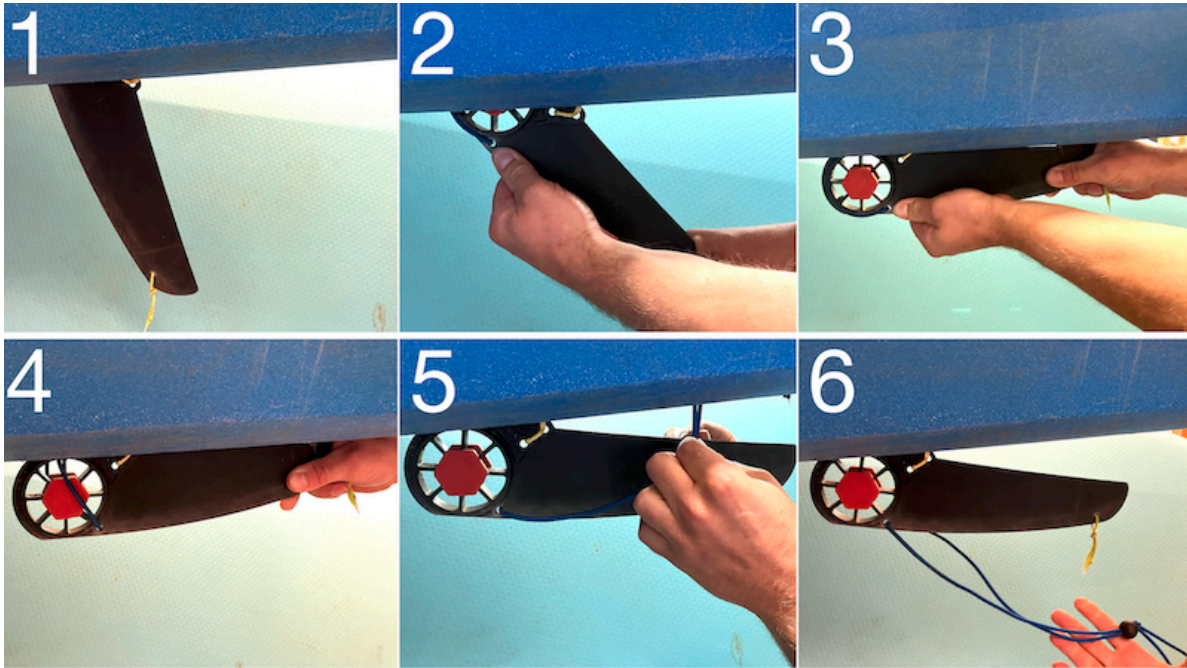

Figure 5.1: Looking into the skeg box from the bottom of the boat. Note the red elastic running around the grooves in the blade and to the ferrule in the back of the skeg box. The red axle component is also visible.

5.1 Removal and re-fitting of the blade assembly

Blade removal:



To remove the blade from the boat:

1. Move the slider to the rear, so that the blade deploys.
2. Pull the blade downwards out of the skeg box.
3. As the blade pulls out, allow it to pivot forwards.
4. Loosen the elastic from the grooves in the blade
5. Pull down on the elastics to remove the ferrule from the skeg box. It may help to free the ferrule with a long screwdriver.
6. Elastic and ferrule removed from boat. If you're lucky you may be able to untie the cord at this point - although it is probably sensible to replace the cord if you're replacing the blade. Once the blade is separated from the cord, or the cord is loosened from the slider, the blade assembly can be pulled free of the boat.

Blade refitting:

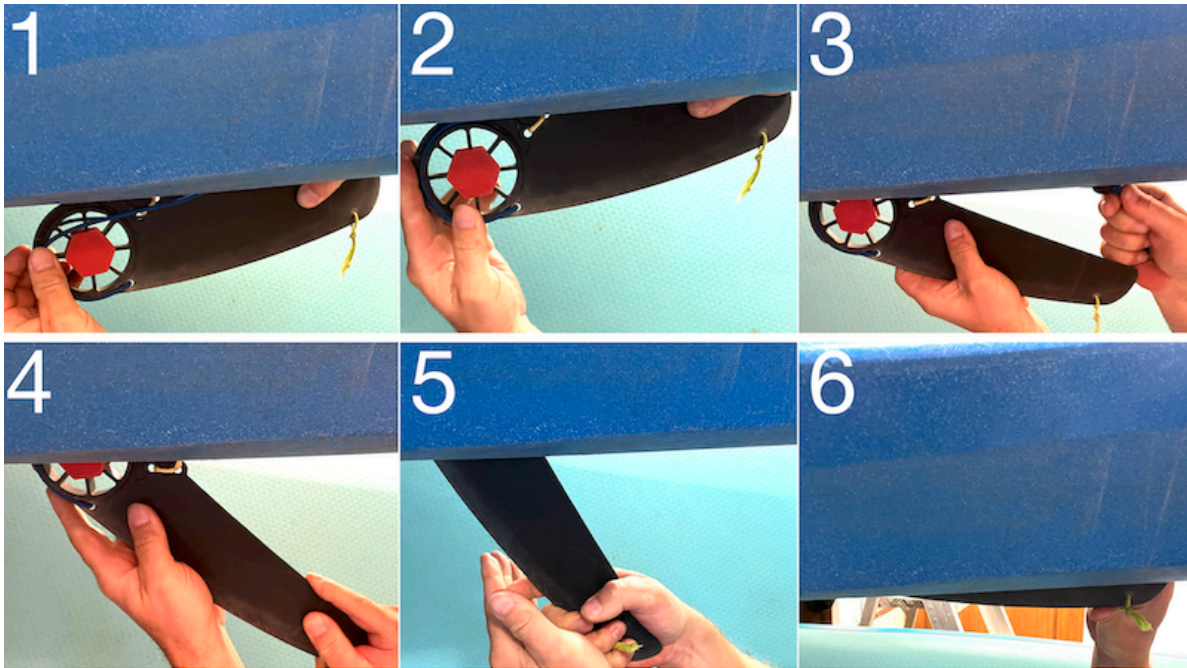

To re-fit the blade into the boat:

1. Hold the ferrule with one hand above and to the rear of the blade. With the other hand, run the elastics into the grooves in the blade
2. Ensure the elastics run all the way around the grooves before continuing
3. Push the ferrule into the skeg box behind the ridges that prevent it moving forward. Push the ferrule upwards as far as is easy with your fingers - there is no need to push it to full depth at this point
4. Align the axle with the slot in the boat's skeg box.
5. Push the blade upwards, sliding the axle into position.
6. Swing the rear of the blade upwards to fully seat the ferrule.

Check that the blade can retract fully into the boat and that it rotates freely on the axle. If the blade does not seat far enough into the boat, take it out and screw the two halves of the axle together a little before trying again. If the blade does not rotate freely (or the axle is loose in the skeg box), try screwing the two halves of the axle apart a little. When making this adjustment, the elastics and ferrule do not need to be inserted into the skeg box.

It is easier to adjust the length of the cord at the controller end, although it is possible (if fiddly) to adjust the knot on the blade.

5.2 Replacing the elastic

The elastic can be adjusted as it wears by tying a knot closer to the blade, but ultimately a new length of elastic (shock cord) will be required. Remove the blade from the boat as described above. There is no need to untie the cord unless you are replacing it. Cut any cable ties securing the elastic to the blade and untie and remove the old elastic, keeping the ferrule.

It seems better to use 4 mm elastic for the replacement - this seems to work better than the 2 mm elastic fitted to some boats to reduce resistance with the old Mk1 controller. Cut the elastic to length (likely a bit shorter than the old stretched elastic) and pass through the hole in the blade that the old elastic passes through. Push both ends of the new elastic through the hole in the ferrule (this can take some fiddling and some force - pliers can help, as can putting a taper on the end of the elastic when you heat seal the ends). Tie an overhand knot in the ends of the cord to prevent it from slipping back through the ferrule.



Figure 5.2: Ferrule. The hole is on the small side for two 4mm elastics.



Figure 5.3: Overhand knot in elastics behind the ferrule

Run the cords around the skeg blade grooves and hold the cord in tension as you replace the skeg blade and then the ferrule into position (see directions for re-fitting the blade above). Cable ties are not required to hold the elastic in place - P&H have used them on some boats but not others. It may be a little awkward to keep the cord in place during insertion into the boat, but it works fine if you maintain a little tension. Over time, the elastic sets a little into place and this becomes easier.

Adjust the tension (see below) and then replace the skeg blade into the boat (see above).

5.3 Adjusting the elastics

The elastics need to be taut enough to pull the skeg down, overcoming any friction in the system. They also need to keep the skeg deployed when the boat is moving at speed - this may be especially important for those using sailing rigs. However, if the line is too taut, it will be difficult to operate the slider to bring the blade back up and the elastic will likely age faster.

In order to adjust the system, deploy the blade and use a long screwdriver or a thin pair of pliers to remove the ferrule from the skeg box. Alter the position of the overhand knot on the cord - closer to the axle for more tension, further away for less. P&H have recommended applying just enough tension to hold the elastic straight with the blade fully deployed, then tying a knot 15 mm forwards of the ridges in the skeg box.

Replace the ferrule into its position and actuate the skeg blade manually to check the tension.

5.4 Adjusting the axle width

The red axle on which the skeg rotates is constructed from 2 parts which screw together. The parts are sometimes glued together, but a sharp twist should break the bond.

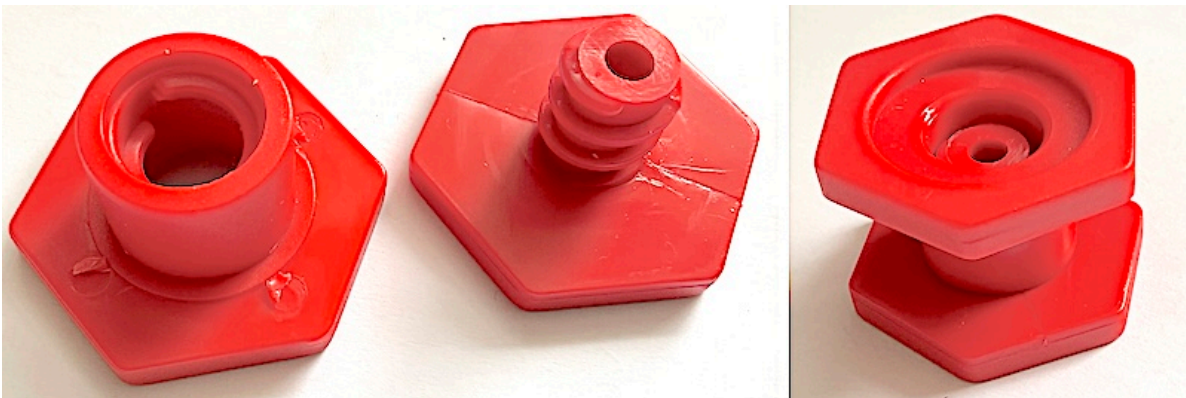

Figure 5.4: Axle disassembled and screwed together

Twisting the hexagonal parts of the axle relative to each other allows the width of the axle to be adjusted. The slot in the skeg box prevents this rotation once the axle is installed. If the axle is set too wide, it will not fit into the slot. If it is set too narrow, the hexagonal parts will squeeze on the blade, preventing it from rotating freely.

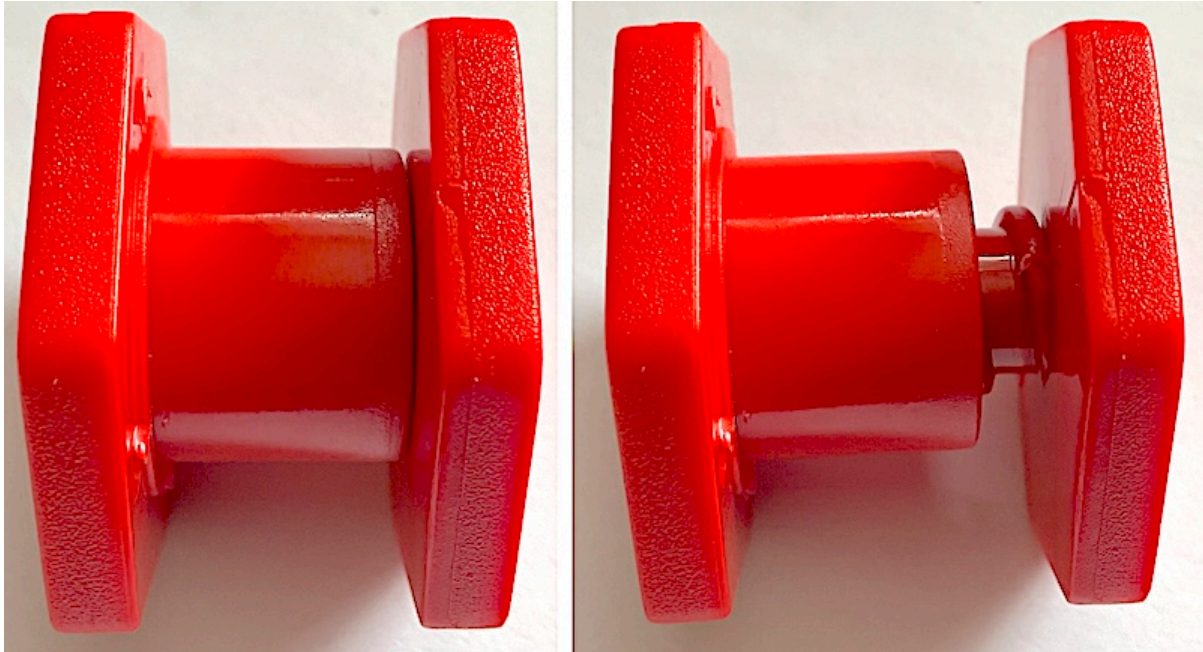

Figure 5.5: Axle at different width adjustments - screwed together fully and hence narrow (left) and unscrewed a few turns and (very) wide (right).

The slot is tapered. If the axle is made wider, it will sit a little lower in the slot. If it is made narrower, the axle, and thus the blade, will sit a little higher. This affects the length of cord that is needed in the system. When the skeg is retracted, there is a short length of cord between the top of the skeg box and the tie in holes on the blade. This length will be longer if the axle and blade sit lower. This must be borne in mind if adjusting the axle width. It also allows the user to use axle width adjustments to compensate for small errors in cord length, as a temporary fix.

5.4.1 Blade length

I once came across a problem with a Scorpio LV, where the blade needed a slight tug to bring it down through the first few degrees of operation. On close inspection, we found that the very tip of the blade was jamming into the back top of the skeg box. Seemingly, the blade was too long, or the skeg box was too short! My plan to gently file the end off was overruled by Pete from Summit to Sea who took an angle grinder to it, which solved the problem. Excellent (if slightly alarming) after sales support!

5.4.2 Blade spokes catching on axle part

If the mechanism feels like it is catching every few degrees, it may be that the spokes of the blade are interfering with the flats of the red axle component. The solution is to gently shave a bit of plastic off each spoke with a craft knife.

5.5 Skudder-type actuator

The skudder-type skeg is based on the Skudder system, in which the blade can be used as a rudder when fully deployed. In the skeg-only system, the blade is prevented from rotating. The controller and tube are the same as for the Mk2 system, but the actuator end is rather different.

Most of the system components, except for the blade assembly, can be seen by opening the actuator cover on the back deck of the boat. This is done by pulling the cover up, then reaching under it to release the cover elastic toggle to de-tension the elastics that hold it in place. The cover is re-fitted by pulling the cover elastic through the cover elastic toggle to tension it, then releasing the cover to drop back into its recess.

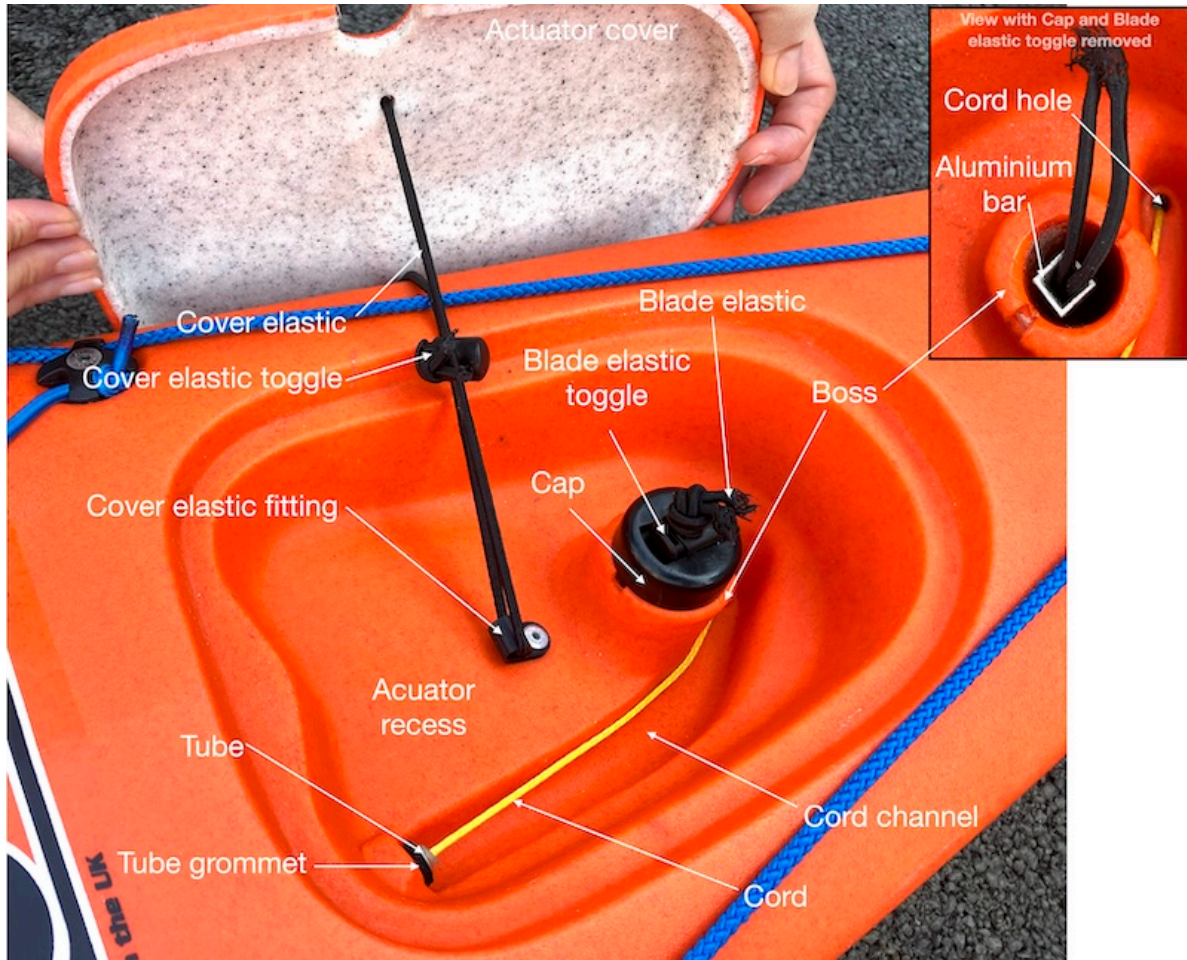

Figure 5.6: The Actuator Recess with cover pulled aside

Below the Actuator cover is the Actuator recess, a hollow moulded into the boat. The Cover elastic fitting is screwed into the bottom of the actuator recess. The cover elastic runs from the cover elastic fitting to the actuator cover and holds the actuator cover in place. The Cover elastic toggle is used to tension the cover elastic.

The tube enters the actuator recess through the tube grommet. There is no fitting that positively locates this end of the tube. The cord exits the tube and runs around the cord channel (a channel moulded into the boat), and down the cord hold towards the blade.

The blade fits to the aluminium bar which runs from the skeg box to the actuator recess, through a hole in the boss, a moulded feature in the actuator recess. The aluminium bar fits to the cap. The cap has a square feature which keys to the aluminium bar and ridges which locate in a slot across the boss - this prevents the aluminium bar from rotating. The blade elastic is attached to the blade assembly. The blade elastic runs through the centre of the

aluminium bar and through a hole in the cap. The blade elastic is tensioned to hold the blade assembly into the boat by the blade elastic toggle and a knot.

The blade assembly is shown below removed from the boat:

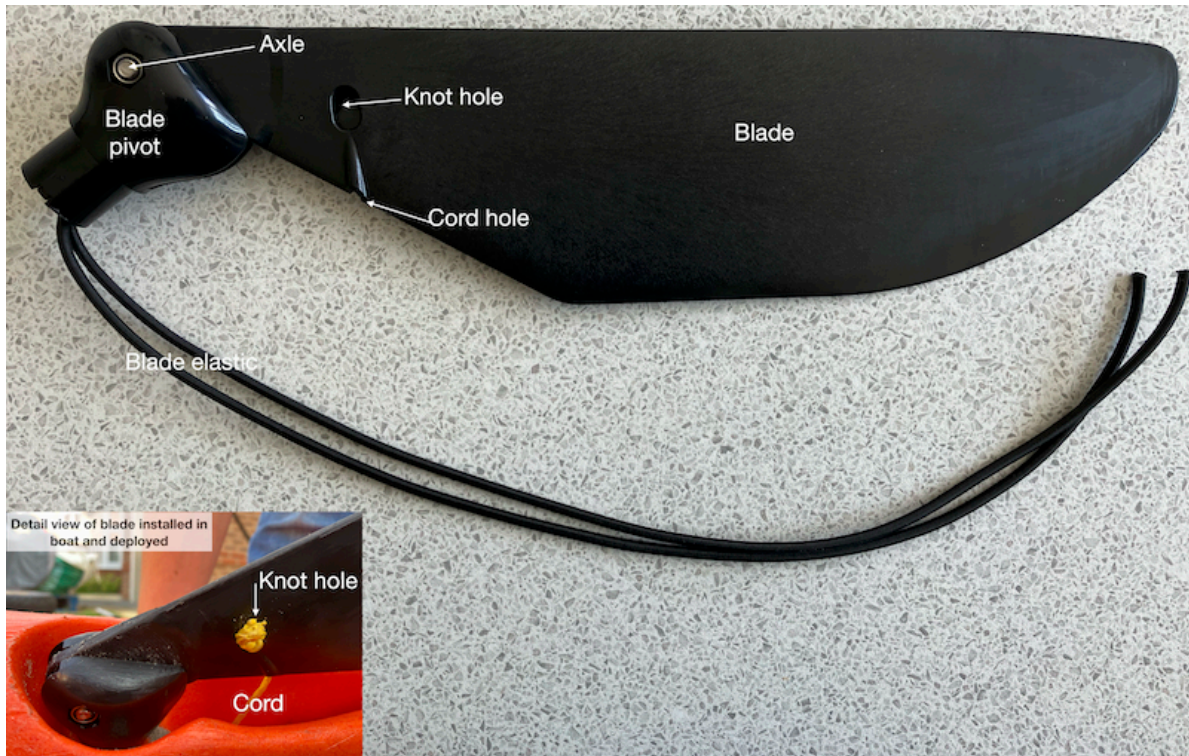

Figure 5.7: Skudder-type blade assembly removed from boat

The blade assembly is supplied as a single part which is not intended to be disassembled. This single assembly contains the axle about which the blade pivots and a spring which pushes the blade down. As such, there is no need for a separate axle and the elastics used in the Mk2 system to deploy the skeg.

The blade assembly consists of the blade and the blade pivots, connected by an axle about which the blade can pivot. A spring in the blade pivot rotates the blade out of the boat (anti-clockwise in image above, the blade is shown in the deployed position). The blade elastics are attached to the top of the blade pivot. The blade pivot has a recess that assembles to the aluminium bar.

The cord passes through the cord hole in the back of the blade. It exists through the knot hole. A simple stopper knot in the cord here keeps it from pulling back out of the blade.

5.5.1 Blade assembly removal

To remove the blade assembly, begin by opening the actuator cover as described above.



Figure 5.8: Removal of the skudder-type skeg blade assembly

Then:

1. Untie the knot in the blade elastic
2. Remove the blade elastic toggle
3. Remove the cap
4. Move the slider to the back of the ratchet box such that the blade deploys
5. Pull the blade down and out of the boat, allowing it to rotate
6. Untie the knot in the cord and remove the cord from the blade

The blade assembly and also the aluminium bar can then be removed from the boat.

Reassembly follows essentially the reverse process:

1. Thread the blade elastics through the aluminium bar and fit the aluminium bar to the blade pivot such that it locks into the square recess
2. Place the blade assembly into the boat, running the aluminium bar into the large hole running to the actuator recess
3. Thread the blade elastic through the cap and then through the blade elastic toggle
4. Assemble the cap to the boss, ensuring the ridges align to the grooves in the boss
5. Tension the blade elastic with the blade elastic toggle and tie an overhand knot in the blade elastic

Many of the reassembly steps involve threading the blade elastic through various components. This can be fiddly, and pliers may help. Heat sealing the ends of the blade elastic helps. Use a candle to seal the ends of the blade elastic in situ.



Figure 5.9: Sealing the blade elastic ends using a candle

6 Diagnosing problems

The following notes are intended to help those less familiar with the system diagnose problems, and work out which of the procedures described in this guide to perform.

The blade does not fully deploy: The blade should deploy to about 70 ° to the boat, such that the half the lower cord hole in the blade can be seen. If the blade does not drop this far when the slider is moved to the back of the ratchet box, check:

- Can the slider be moved to the front of the ratchet box? If not, the cord is too short. it will need to be replaced and set to the correct length
- Can the blade be moved into the correct position by hand? If so, the problem is either insufficient tension in the elastic or friction in the system. Try tensioning the elastics first - if this is hard, or the elastics are clearly degraded, they may need replacing. Replacing 2mm elastics with 4mm elastics may help. Moving the slider button to the rear of the ratchet box and actuating the blade up and down by hand (possibly with the elastics removed or slack) will allow you to assess the friction and judge what is causing it. Adjusting the width of the axle may help. Note that axle adjustment causes the blade to sit at a slightly different height in the skeg box - this may cause the cord length to require adjustment.

The blade does not fully retract: when the slider is moved to the front of the ratchet box, the blade does not fully retract into the boat. When the slider is moved to the back of the ratchet box, the blade drops too far.

- This generally means that the cord is too long. Remove the slider from the ratchet box and adjust cord length.
- Check that the tube is correctly held in position at the skeg box - failure of the retaining washer can cause the tube to slide in the box insertion resulting in unexpected performance.

The slider is hard to move. Check if the difficulty comes from the ratchet box itself, the blade actuation or the cord running in the tube. Tape the skeg in the up position and see if the slider is still hard to move - if so, the problem is likely in the ratchet box. If the slider is now easy to move, the problem is at the actuator end. Cord friction in the tube can be assessed by disassembling the controller, removing the blade from the skeg box and manually sliding the cord through the tube.

- If the problem is in the ratchet box, establish if the slider box is a Mk1 (metal bar) or Mk2 (composite bar). Mk1 slider boxes should be replaced if possible. In the Mk2 slider, the problem can be a failure of one of the axles in the slider - replace the slider. Also check that the screws holding the bar in place are not loose. Check for wear (flats) on the bar. It can be useful to spray silicone lubricant all over the controller as a temporary fix for worn parts.
- If the problem is at the actuator end, begin by de-tensioning the elastic. If this solves the problem, set the elastic tension a bit lower. If the problem remains, actuate the blade by hand to feel the friction and assess where it is coming from. The axle width may need adjusting.
- The problem will rarely be in the cord / tube. If it is, try to establish where the problem is - check for kinks or knots in the cord. The cord and/or tube may need replacing.

The slider actuates too easily. This often occurs as the system gets worn. It becomes difficult to accurately set the blade at a defined angle (the ratchet tends to slip), it's hard to put the blade fully up, and the blade drops fully when the slider is knocked (often happens during landings).

- Replace the composite rod in the skeg box and/or the slider button.

It is difficult to get the blade to drop the first few degrees - beyond that it drops fine.

- Check if the tip of the blade is contacting the back of the skeg box. If it is, it may need filing / grinding shorter
- Check for contact between the blade spokes and the axle - you'll feel this as it catching every few degrees. If this occurs, you may need to cut the spokes back a little, or round the corners of the axle.

System replacement: If you really don't like the P&H system and have a composite boat, it is possible to replace with a wire skeg - see instructions [here](#).